

Redx

Red

User Manual

RX SERIES ALL IN ONE

RX-2505AC

dx

The Redx logo features a stylized 'A' inside a circle, followed by the word 'Redx' in a bold, sans-serif font.

Redx



All Rights Reserved

No part of this document can be reproduced in any form or by any means without the prior written permission of Redx.

Trademarks

Redx

and other Redx trademarks used in this manual are owned by Redx.

All other trademarks or registered trademarks mentioned in this document are owned by their respective owners.

Software Licenses

It is prohibited to use data confirmed in firmware or software developed by Redx, in part or in full, for commercial purposes by any means.

It is prohibited to perform reverse engineering, cracking, or any other operations that compromise the original program design of the software developed by Redx.

Contact Us

Redx Technology Australia Pty Ltd

Address: U2 /21 Millennium Circuit, Helensvale, Australia 4212

Tel: +61 7 5672 9983

Email: info@redxenergy.com.au

Website: www.redxenergy.com.au

ABN: 76614340546

About This Manual

This manual mainly describes the product information, installation, operation, and maintenance guidelines of the Redx energy storage system. Please read this manual carefully before using this product and store the manual in a safe place. Redx will not notify the user of any changes to this manual.

This manual applies to the RX-2505AC all in one energy storage integrated system. The system must be installed by a qualified/licensed technician. The battery chemistry in the all-in-one energy storage system is lithium iron phosphate. We strongly recommend that installers read this manual carefully. The manual includes the guidance on product installation, troubleshooting, communication and other aspects.

Table of Contents

1 Safety	1
1.1 Important Safety Instructions.....	1
2 Product Introduction	3
2.1 System Diagram.....	3
2.2 Production Introduction.....	4
2.2.1 Appearance and Dimensions.....	4
2.2.2 Dimensions and Weight.....	6
2.3 LED Indicator Panel and Switches.....	6
2.4 Name Plate Labelling.....	7
2.4.1 Product Benefits.....	8
2.5 Scope of Delivery.....	8
2.6 Storage.....	8
3 Installation	9
3.1 Installation Preparation.....	9
3.2 Installation Tools.....	10
4 Installation Guide	11
4.1 System Wiring Diagram.....	11
4.2 Installation Procedure.....	12
4.3 Earth Connection.....	12
5 Cable Connection	13
5.1 Connect Cables to the AC Grid Side and off-Grid Side.....	13
5.2 CT/METER Connection.....	17
5.3 External RS 485 Connection.....	19
5.4 Connection of DRMO Terminal (Australia Only).....	20
6 Operation	21
6.1 Checklist before operation.....	21
6.2 Operation checks.....	22
6.3 Operation modes.....	22
6.3.1 Operating modes.....	22
6.3.2 Fault state.....	23
6.3.3 Firmware update.....	24
6.3.4 Self-check Status.....	24
6.3.5 Standby Status.....	24
6.3.6 Protection Mode.....	24
6.3.7 Shutdown Status.....	23
6.4 Communication.....	24
7 RX-2505AC System Turn on and Turn off	24
7.1 Turn on RX-2505AC System.....	23
7.2 Turn off RX-2505AC System.....	24
8 Troubleshooting & Maintenance	24
8.1 Troubleshooting.....	24
8.2 Maintenance.....	27
8.3 Routine Maintenance.....	28
9 Redx Power App	28
10 Quality Assurance	28
11 Appendix	30
11.1 Product Specification.....	30
11.2 Optional Accessories.....	32
12 Contact	33

• 1 Safety

• 1.1 Important Safety Instructions

The Energy storage system has been designed and tested strictly according to international safety regulations. Read all safety instructions carefully prior to any work and always observe them when working with the energy storage system.

Incorrect Operation or Work may cause:

- Injury or death to the operator or third party.
- Damage to the inverter and other property or third party.









Safety Instructions



- (1) Do not open the case as risk of electric shock is present.
- (2) Maintenance should be carried out by a professional licensed technician.
- (3) Read this manual before operating the system. Redx is not responsible for failure or loss arising out of improper operation.
- (4) All wiring, installation, commissioning, and other work should be done by a professional licensed technician.
- (5) Ensure that the storage unit is not installed or used in the following locations:
 1. Poorly ventilated room.
 2. Places with flammable gases or corrosive materials and large amounts of dust.
 3. High or low environment temperature (above 50°C or below 0°C), or high humidity (greater than 90%).
 4. In direct sunlight or near heating equipment.
 5. Outdoors (indoor installation only)
 6. Do not use anything to cover the inlet and exhaust of the module.

In case of fire, use dry powder fire extinguishers instead of liquid fire extinguishers.

All electrical connections are subject to the local grid safety regulations and the storage system should be reconnected to the grid under conditions of approval.

Table 1-1 - Warnings

	<p style="text-align: center;">Danger!</p> <p>Removal of any protection, incorrect use, incorrect installation, or incorrect operation may result in death / serious personal injury or device damage. Transportation, loading and unloading, installation, start-up and maintenance must be carried out by qualified or trained engineer/technician.</p>
 	<p style="text-align: center;">Danger!</p> <p>Before maintenance or touching any parts, or installation, make sure that the energy storage unit is disconnected and wait 5 minutes to ensure that the internal capacitor is discharged</p>
	<p style="text-align: center;">Danger!</p> <p>Do not connect the grid cable to the EPS output, otherwise it may cause Serious damage to the system and load.</p>
	<p style="text-align: center;">Warning!</p> <p>Installation must be in full compliance with national and local laws and regulations.</p>
	<p style="text-align: center;">Warning!</p> <p>Ensure that the system is positioned correctly and is not allowed to roll sideways or upside down.</p>
	<p style="text-align: center;">Warning!</p> <p>Do not change the internal circuit of the machine without permission.</p>
	<p style="text-align: center;">Warning!</p> <p>Before connecting to the grid, system the must be connected to the Ground. Follow the instructions. Improper operation may cause serious damage.</p>
	<p style="text-align: center;">Notice!</p> <p>There is a 4G / WIFI device inside the system, do not place the system in an environment where there is no 4G / WIFI signal.</p>

	Warning!
	<p>The product is not tested to section 5 of AS/NZS 4777.2:2020 and is not to be used in multiple inverter combinations without additional considerations by the system designer.</p>
	Warning!
	<p>The load capacity of the output of the inverter is as follows: Inductive load (such as air conditioning, washing machine, motor, etc.): Single maximum power 1.5kVA, total inductive load maximum power 2.5kVA (with grid power). Capacitive load (e.g. computer, switching power supply, etc.) : The maximum power of the total capacitive load is 1.5kVA (without grid power), The maximum power of the total capacitive load is 2.5KVA(with grid power).</p>

• 2 Product Introduction

• 2.1 System Diagram

The RX-2505AC system uses the grid and battery to ensure the continuous power supply to important loads. The system allows users to store the energy from grid into the battery, and send the stored energy to the grid when needed. It can also provide backup power during a power outage.

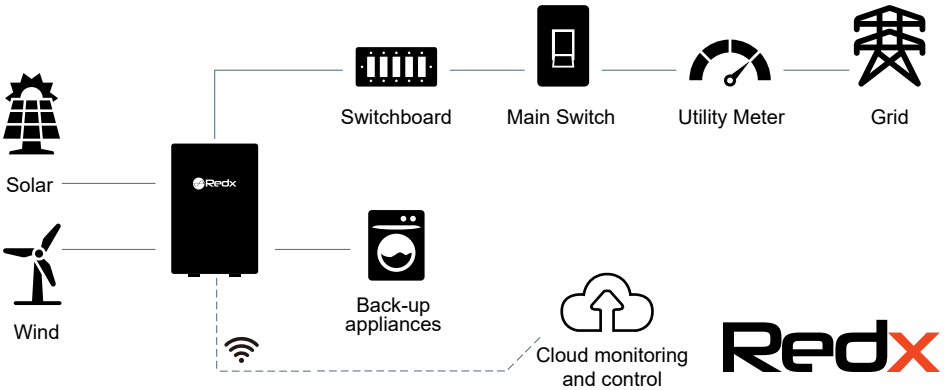

Figure 2-1 – System block diagram

Figure 2-1 shows the application of the RX-2505AC all-in-one energy storage system. RX-2505AC contains the inverter and battery storage modules. It is important to keep the installation environment well ventilated and take necessary measures to control the ambient temperature to avoid the risk of explosion caused by excessive battery temperature.

- 2.2 Production Introduction
- 2.2.1 Appearance and Dimensions

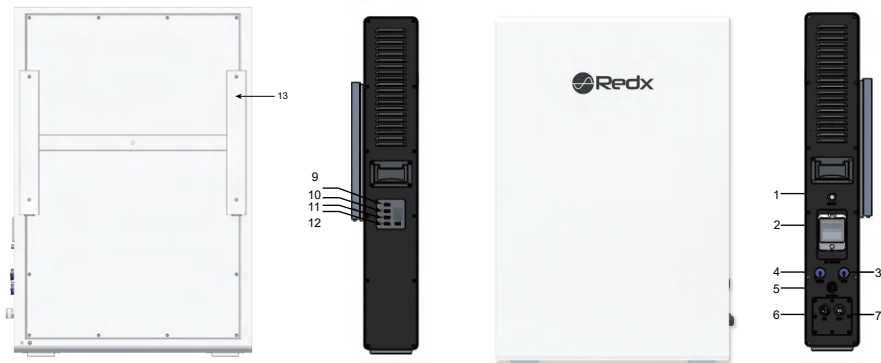

Figure 2-2 – Battery system components

Table 2-1 – Battery components details

Items	Name
1	Main power Switch
2	Battery air circuit-breaker
3	DRM0 RJ45 Terminal
4	RS485(USB)
5	CT/METER Terminal
6	EPS Terminal
7	AC Terminal
8	Battery status indicator
9	Run Indicator light
10	VPP Indicator light
11	Grid Indicator light
12	Battery Indicator light
13	Mounting bracket

- 2.2.2 Dimension and Weight



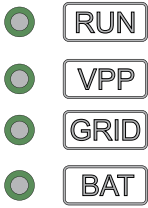

Figure 2-3 – Battery system dimensions

Table 2-2 – Battery systems dimensions details

A (mm)	B (mm)	C (mm)	Weight
145	600	900	75Kg

• 2.3 LED Indicator Panel and Switches

Table 2-3 – Battery interface details









Items	Name	Function	
 <p>AC ON - OFF</p>	Switch button	Turn on / off the system	
	Operating status	RUN	Normal - Green
Fault - Red			
VPP		VPP control - Green flash	
		Remote control - Blue flash	
GRID		Grid connected - Green	
		Grid disconnected – Blue	
BAT		Charging – Green	
		DisCharging – Blue	
	SOC	Battery status	
	Battery circuit-breaker	Air circuit-breaker between battery and inverter	

• 2.4 Name Plate Labelling

RX-2505AC label contains the following information.

Table 2- 4 – Battery label specifications

Battery Storage System	
	
RX-2505AC	
Model Name	RX - 2505AC
AC Output / Input Data	
Rated Input / Output Power	2500W
Rated Output Apparent Power	2500VA
Nominal Voltage	230Vac
Rated Input / Output Current	10.8A
Nominal Frequency	50Hz
Power Factor Range	0.8Leading - 0.8Lagging
EPS Output Data	
Nominal AC Output Power	2500VA
Nominal AC Output Voltage	230Vac
Nominal AC Output Frequency	50Hz
Rated Output Current	10.8A
Others	
Battery Capacity	4800Wh
Protective Class	Class I
Ingress Protection	IP32
Inverter Topology	Isolated
Operation Ambient Temperature	Charge: 0°C ~50°C
	Discharge: -20°C ~50°C
Software Version	V2.10.00

      
 <p>001XOJF050001B</p> <p>Redx Technology Australia Pty Ltd www.redxenergy.com.au</p> <p>Made In China</p>



2.4.1 Product Benefits

- a. Backup power supply, peak shaving, asset management.
- b. Integrated design, save installation time and costs.
- c. Smart management, different operating modes.
- d. Battery safety management system.
- e. Remote scheduling, intelligent management.
- f. Multiple protection.

2.5 Scope of Delivery

Please check the condition of the packing before unpacking. If any parts are damaged or missing, contact your local supplier for help.

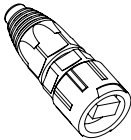
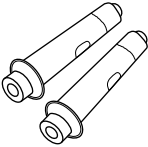
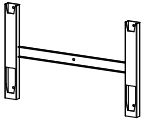
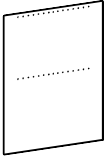
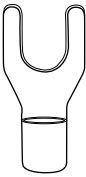
Table 2-5 – Parts in the box

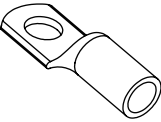
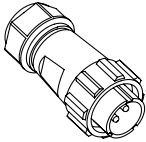
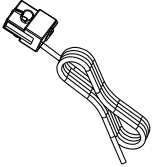
				
RX-2505AC	RJ45 connector	M6 Anchor bolts	Mounting Bracket	Hole template
1PCS	1PCS	5PCS	1PCS	1PCS
				
M4 spade terminal	Install Document	M5 spade terminal	4 Pin CT connector	CT
5PCS	1PCS	1PCS	1PCS	2PCS

2.6 Storage

Store the unit properly when the unit is not installed immediately.

- Store the unit in the original packaging box
- Storage temperature should be always between 0°C and 50°C+
- Package dimensions 1025x755x330(mm), weight 101.5kg
- Maximum stacking 5 pallets

Storage temperature	-20°C~ 45°C	Less than ① month
	15°C~ 35°C	Less than ⑥ months

Table 2-6 – Storage temperature



Figure 2-4 - Packaging

• 3 Installation

• 3.1 Installation Preparation

- a. Indoor installation only, IP32.
- b. Vertically mount only.
- c. Install in a ventilated location. There must be enough clearance to ensure that the module operates in the optimal heat dissipation state.
- d. Install at suitable distance from any restricted areas, please review Standard ASNZS5139.
- e. Install on a sturdy supported surface.
- f. The location must support the weight and size of the module.
- g. The environmental temperature must be between 0 °C and +50 °C, and the relative humidity between 0% and 90% (without condensation).
- h. Check the fans in the unit regularly.
- i. Location shall be dry with adequate air flow (pollution level < 2) and without excessive dust
- j. Wiring terminals require protective covers.
- k. Installation is prohibited in any of the following environments:

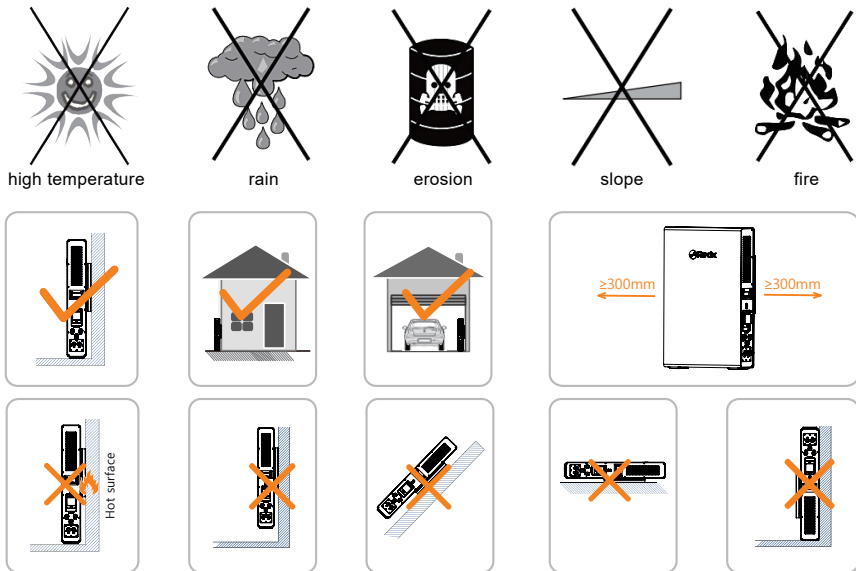

Figure 3-1 – Installation locations























The minimum clearance on the sides must be maintained at least 300mm.

- a. Installation location of the system should be easy for operator to turn off at any time.
- b. Do not install the system near signal transmitters.
- c. Do not install the system in the living area.
- d. Do not install the system at location where children can easily access.

• **3.2 Installation Tools**

Prepare the following tools before installation

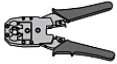
Table 3-1 – Installation tools

Type	Tool			
General tools	 <p>Packaging tape</p>	 <p>Marker</p>	 <p>Measuring tape</p>	 <p>Level</p>
	 <p>Utility knife</p>	 <p>Multimeter Measurement range: ≥ 1100Vdc</p>	 <p>Protective clothing</p>	 <p>Wrist strap</p>
	 <p>Protective gloves</p>	 <p>Dust mask</p>	 <p>Earplugs</p>	 <p>Goggles</p>
	 <p>Insulated shoes</p>	 <p>Vacuum cleaner</p>		
	Installation tools	 <p>Hammer drill bit</p>	 <p>Rubber mallet</p>	 <p>Slotted screwdriver</p>
 <p>Wire stripper</p>		 <p>Hydraulic clamp</p>	 <p>Crimping pliers</p>	 <p>Wire nippers</p>
 <p>Crystal head crimping pliers</p>		 <p>Percussion drill</p>		

• 4 Installation Guide

• 4.1 System Wiring Diagram

Figure 4-1 shows the wiring topology (dashed boxes indicate optional components) of the RX-2505AC all-in-one energy storage system. The RX-2505AC can be connected to a maximum of two wired CTs, please note that the CT cable length should not exceed 10m.

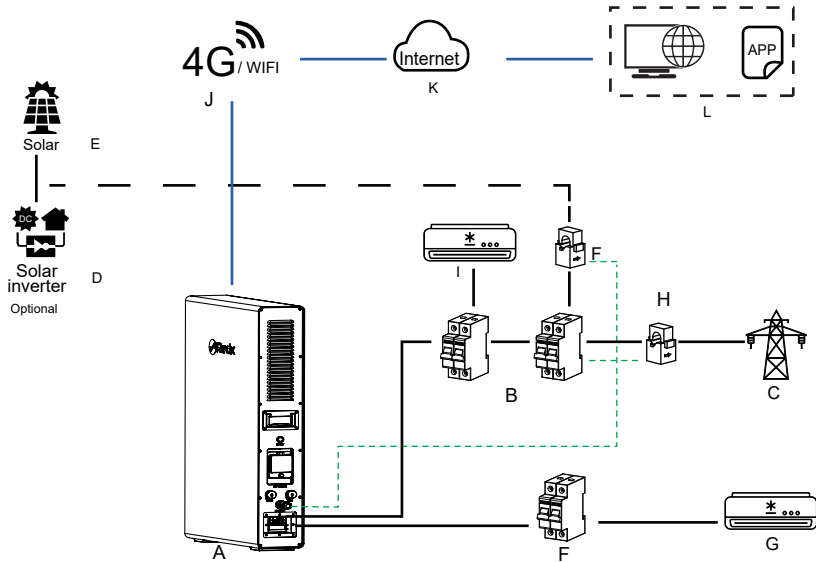

Figure 4-1 – Battery system connections topology

Black indicates a power cable Blue indicates a signal cable , Green indicates wireless communication
The explanation is as follows:

Table 4-1 – Battery connection details

Number	Name
A	RX-2505AC
B	Circuit breakers for Grid connection, PV, Regular Loads and RX-2505AC
C	Grid
D	Solar inverter (optional)
E	Solar panels (optional)
F	EPS Circuit breakers
G	EPS Back up Loads
H	Current Transformers / Smartmeter
I	Regular Loads
J	Wi-Fi router / 4G module
K	Internet / Cloud platform
L	Redx Power App / Web portal

• 4.2 Installation Procedure

1. Align the hole template (locating plate) with the ground and place it flat on the wall.
2. Align the hole template on the installation surface and drill holes with a diameter of 8mm and a depth of 40mm on the wall.
3. Install the m6x60 expansion screws into the previously drilled holes.
4. Secure the fixing bracket to the wall using a socket wrench and tighten the expansion bolts.
5. Align the unit with the fixing bracket on the wall and lift the unit on to the bracket by lowering it into the holes.
6. Prepare the unit for installation of cabling.

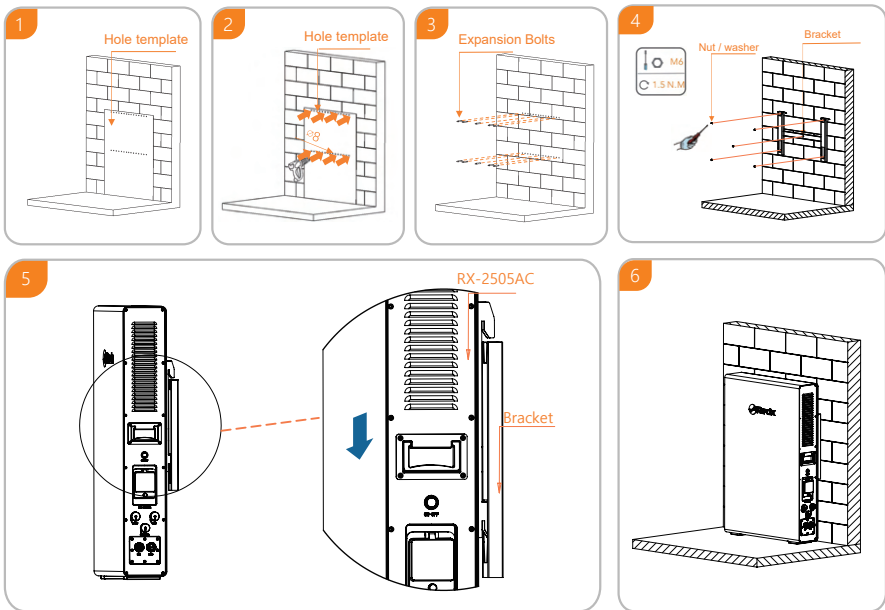

Figure 4-2 – Battery unit mounting steps

• 4.3 Earth Connection

A secondary protection grounding terminal can be found on the system. Ensure that the grounding resistance is less than 10 Ω and the grounding cable diameter is not greater than 10mm².

• 5 Cable Connection

• 5.1 Connect Cables to the AC Grid Side and off - Grid Side

RX-2505AC has terminals for on and off-grid. As shown in Figure 5-1, the left terminal is the off-grid terminal (EPS) and the right terminal is the on-grid terminal. An independent AC circuit breaker must be configured for each circuit to safely disconnect then system. When selecting the external cable, consider the hole in the cable gland. The table below is a recommendation for cable selection.

Engineers should refer to local standards to select cables. Cable length is generally 2 to 10 meters, long cable will lead to voltage drop from the rated value, consequently requiring an increase of the cross-sectional area.

Recommended specifications of AC circuit breaker:

Table 5-1 – Circuit breaker sizing

Model	AC circuit breaker Suggestion
RX-2505AC	25A

Table 5-2 – Cable sizing

The following table lists the recommended specifications of AC cables

Model	Cross-sectional area (mm ²)		Cable outer diameter(mm ²)	
	Range	Best	Range	Best
RX-2505AC	4-6	4	10-14	14

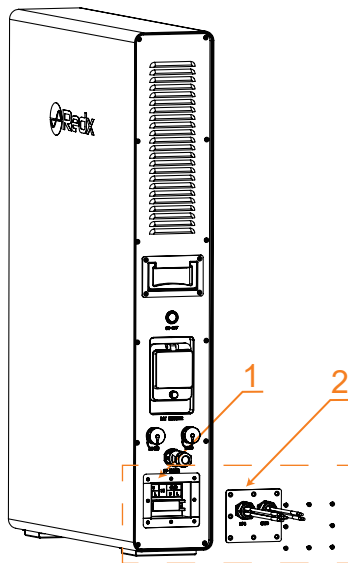

Figure 5-1 – Battery 240V terminals and covers

Table 5-3 – Battery 240V terminal cover details

1	2
RX-2505AC terminals	GRID/EPS wiring cover

Requirements

1. Install an AC circuit breaker between the inverter and the grid before connecting the system to the grid.
2. Grid voltage and grid frequency should be within the allowable range of inverter operation.

Steps

1. First, prepare the required connecting wires according to the following. It is recommended that the live wire be red, the ground wire be black, and the safety earth wire be yellow and green.

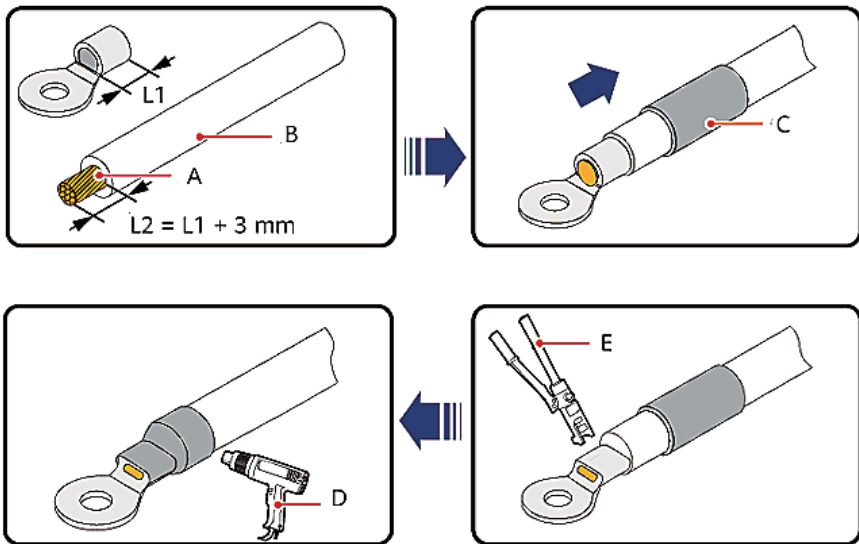

Figure 5-2 – Cable crimping instructions

- | | | |
|---------------|----------------------|------------------------|
| (A) Core wire | (B) Insulation layer | (C) Heat shrink tubing |
| (D) Heat gun | (E) Hydraulic pliers | |

2. Remove the cover of the terminal

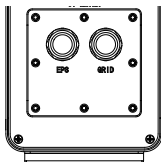

Figure 5-3 - Terminal cover

3. Note the wiring terminals

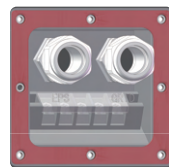

Figure 5-4 - Wiring terminals

4. Connect the cable to the corresponding terminal according to the marking and tighten the screws:

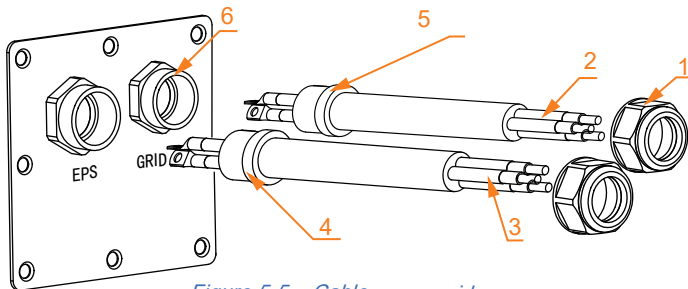

Figure 5-5 – Cable cover guide

Table 5-4 – Cable and cover details

1	2	3	4	5	6
Nuts	GRID 3 core cable	EPS 3 core cable	Rubber seal	Rubber seal	Cover

5. Follow similar steps to connect the off-grid side, ensure that all wires are securely connected and reinstall the cover plate.

The recommended connection is as follows:

This diagram is an example for an installation where Neutral connects to PE in the switchboard. Example countries that have this regulation: Australia, New Zealand. Please follow local wiring regulations!

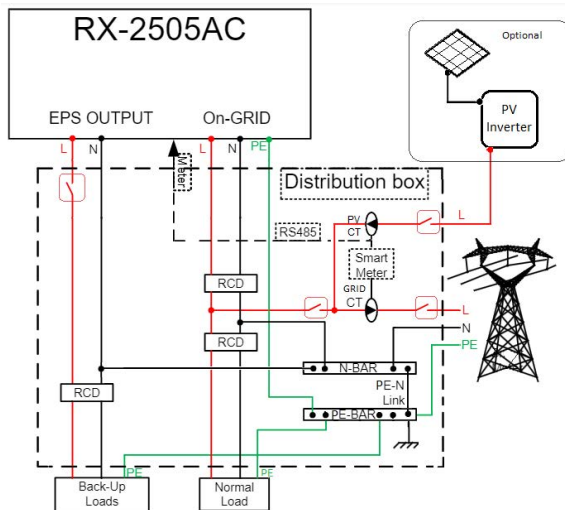

Figure 5-6 – 240V connection diagram of backup power supply (EPS) and On-grid

Note:

The battery inverter does not have an internal RCD as it is isolated. If an external RCD breaker is mandatory in the country of installation, it must be a type A RCD with the rating residual current not more than 30mA.

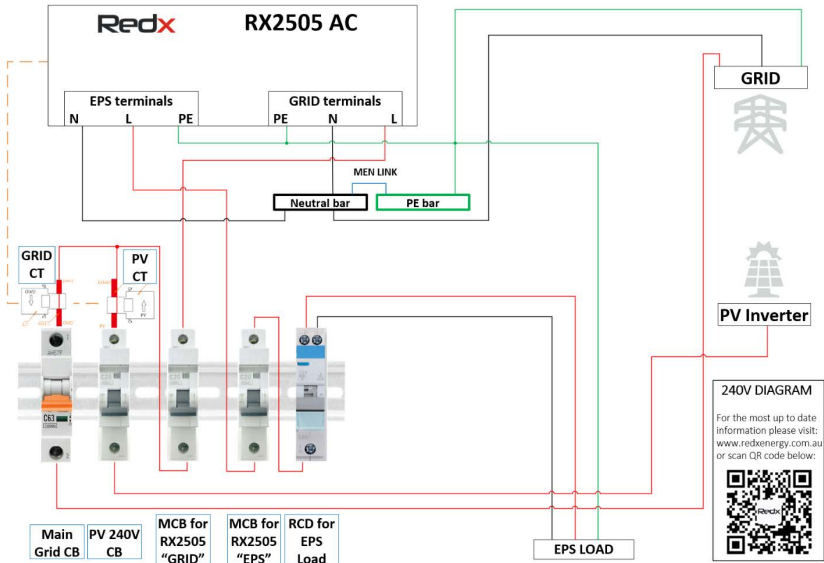

Figure 5-7 - Example switchboard installation

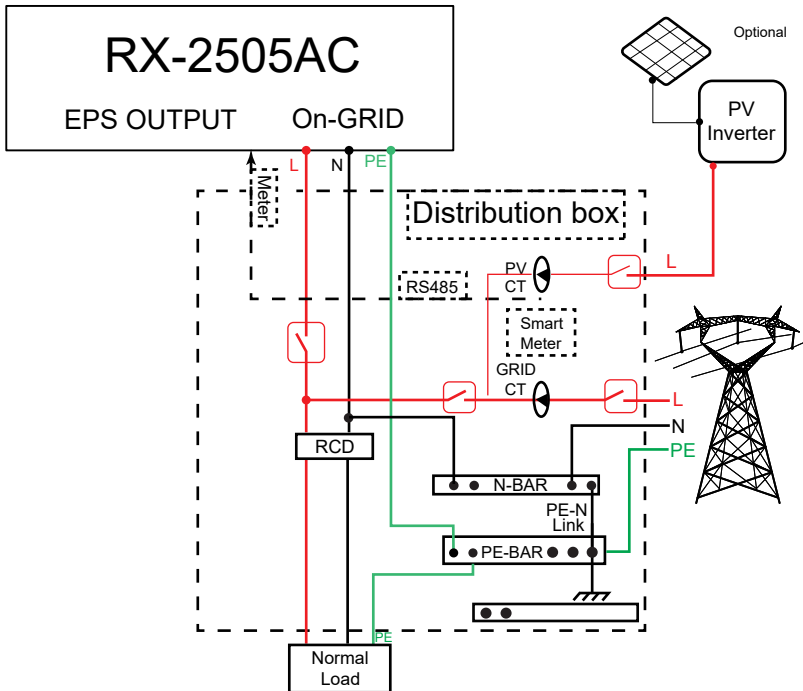

Figure 5-8 – 240V connection diagram On-grid only (no EPS backup)



Note:

- 1.If you only use the grid-connection function, connect it to the grid terminal as shown in Figure 5-8 and do not connect anything to the EPS terminal.
- 2.If you need to use both the grid connection and backup power supply functions, refer to Figure 5-6 to connect cables.
- 3.The grid terminal and EPS terminal cannot be directly connected together, otherwise the system will be damaged.
- 4.The EPS terminal cannot be connected to the grid, otherwise the system will be damaged.
- 5.The battery needs to be activated with the APP when the system starts for the first time.

5.2 CT / METER Connection

The CT / METER is required to monitor the energy usage.

The steps of CT / METER connection are as follows:

1. Unscrew the rubber nut on the water-proof cover of the CT/METER.
2. Connect aviation plug (CT/METER) to the RX-2505AC (CT/METER) port as shown in Figure 5-9.
3. Tighten the aviation plug as shown in Figure 5-10.
4. Connect the corresponding cable according to the label (PV/GRID) on the CT/METER: Label “GRID” is for grid connection, Label “PV” is for PV Connection. See figure 5-7 and find “CT”.

Note:

RX-2505AC can have two CTs connected to it. The CT can also be replaced with smart meter according to customer requirements. Users can choose to use either CT or a smart meter.

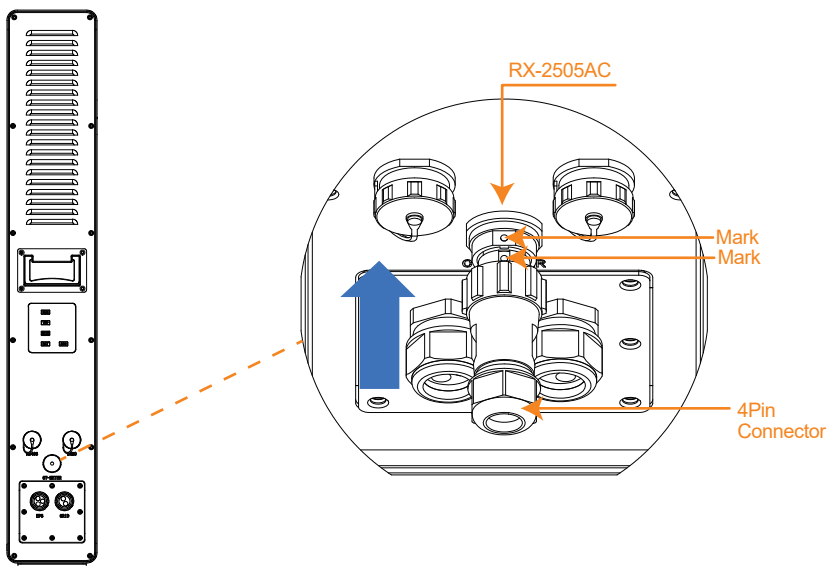

Figure 5-9 – CT connector insertion with white guide marks

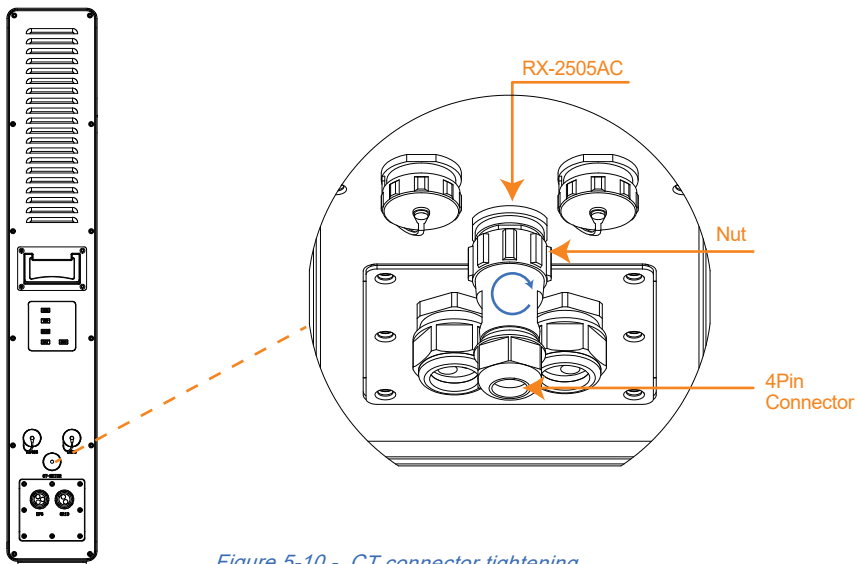

Figure 5-10 - CT connector tightening

CT cable (length: 5m) specifications: if the cable is not long enough, add an extension cable (max 10m), contact the local supplier in advance. The direction of CT installation as shown in Figure 5-11:

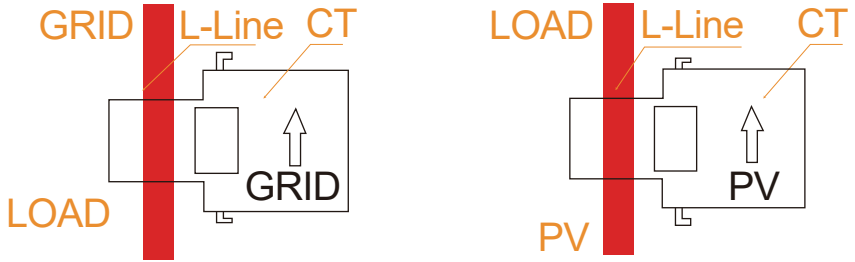

Figure 5-11 – CT polarity

As shown in figure 5-11, an arrow indicates the direction of the CT, pass the cable through the hole of the CT, then close and lock the CT.

Note: On the “Grid” CT the orientation of the arrow (L to G) must be pointing from switchboard to grid. The “PV” CT arrow must point from PV to switchboard. The CTs must be installed in the power distribution box.

• 5.3 External RS 485 Connection

RX-2505AC has a USB RS 485 port allowing customers to connect their own devices.

1. Unscrew the rubber nut on the water-proof cover of the system (RS485);
2. The detail of the USB RS 485 as shown in Figure 5-12;

Note: The RX - 2505AC has a WiFi module inside. If customers use another Wi-Fi module or other communication module, they need use the default USB RS 485 port.

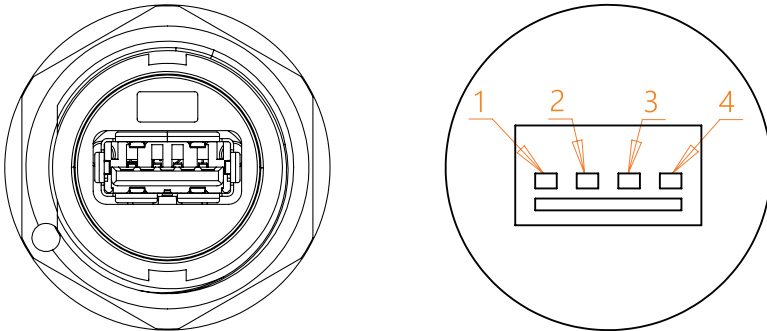

Figure 5-12 RS485 pins

Table 5-5 – RS485 pins details

1	2	3	4
+5V	485_A	485_B	GND

• 5.4 Connection of DRM0 Terminal (Australia Only)

When RX-2505AC is installed in some states in Australia, the DRM terminal needs to be connected. The connection method is as follows:

1. Unscrew the rubber nut on the water-proof cover of the RX-2505AC (DRM0);
2. Make the RJ45 terminal with tools according to the identification in figure 5-14;
3. Tighten the aviation plug as shown in figure 5-13;

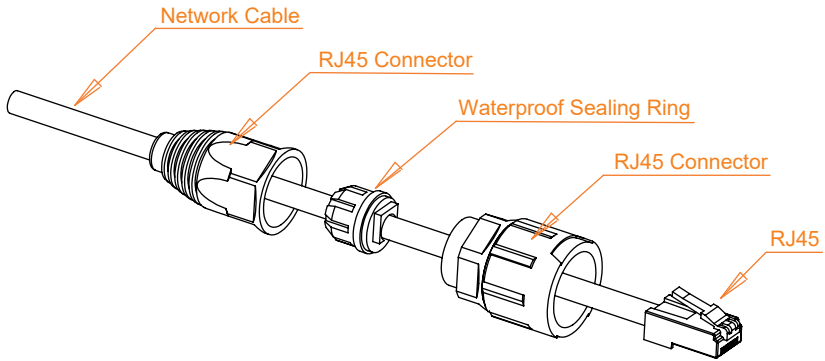

Figure 5-13 - DRM cable assembly

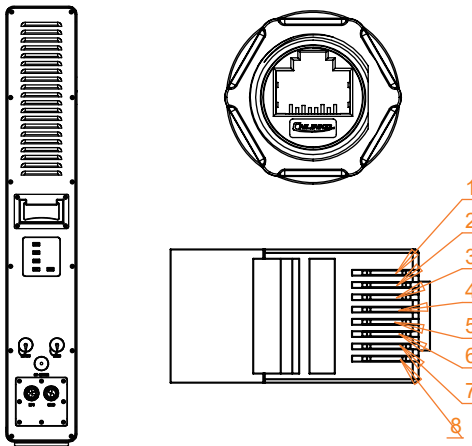

Figure 5-14 - DRM RJ45 pins

Table 5-6 - DRM pins detail

1	DRMO_1
2	DRMO_2
3	N/A
4	N/A
5	N/A
6	N/A
7	N/A
8	N/A

• 6 Operation

• 6.1 Checklist Before Operation

1. Check whether the system is firmly installed, and the installation position is suitable for operation and maintenance.
2. All cables are correctly connected, properly distributed, and well protected, and no mechanical damage is present.
3. The selection of AC circuit breakers is correct.
4. The wiring terminals are securely installed, and the vacant terminals are sealed.
5. All safety signs and warning labels on the system are firmly and clearly visible.
6. The installer must select the correct regional settings for the inverter. The installer will be able to select the correct regional settings in the app during commissioning. Selecting the customer's relevant Grid Operator will automatically allocate the relevant Regional settings. Alternatively the installer can login to www.redxpower.com with their installer credentials. Then they must navigate to Devices page, find their device by typing in the device serial number in the search field, then click on the device serial number and select the correct region in the Deploy section. The installer can also edit the Generation and Export Limit Control Settings on the Deploy page.

✓ Create plant for existing user account

Account: Select

New Plant Details

Plant Address
2/21 Millennium Cct Helensvale, QLD, 4212

Installation Date 2023-01-17

Plant Name
DemoPlant

Plant Type Residential

Grid Operator: Select

Region:

Figure 6-2- Region selector in the Redx Power App

Deploy

Device Sn code: RX2505ACA1030A150008 Internal time: 2023-01-16 23:36:01

Mode: Local mode Discharge depth: 10

Local mode threshold: 300 Charging delay time: 30 Discharge delay time: 30

DMCOon: Off SWBackFlow: On SWBackVal: 0

HDBackFlow: Off HDBackVal: 0 ReActpmode: Off

Generation Limit Export Limit

Load Settings Save

Figure 6-1 - Export Soft and Hard Limit settings on Deploy page

Turning **SWBackFlow** and **HDBackflow** settings to "On" sets the soft export limit to the value of **SWBackVal**, and the hard export limit to the value of **HDBackVal** respectively. Turning both **SWBackFlow** and **HDBackFlow** parameters to "On" enables generation limit control to these values.

• 6.2 Operation checks

1. Confirm that the above checklist meets the guideline.
 2. Turn on the AC circuit breaker.
 3. After the AC circuit breaker is turned on and the LED on the system is on, perform the following tasks:
 - a. If the blue power LED does not light up, check if voltage is present on grid input terminals.
If there is voltage on the grid terminals, but unit is still not illuminating the power button - please contact local Redx dealer.
 - b. Install the Redx Power APP or open the web page according to the attached instructions, and then configure the WIFI connection.
 - c. Turn on the battery circuit breaker on the side of the system.
 - d. Press the power button on the side of the system, then the system is in passthrough state and EPS port has power output.
 - e. Set the needed parameters through the web or APP. The battery LED indicator on the panel lights up and the other LED indicators will light up according to the actual working status.
 - d. If the operation fails, troubleshoot fault by referring to Chapter 9 in this manual
- Note:** Use the grid power and the APP to activate the battery for the first-time operation.

• 6.3 Operation Modes

• 6.3.1 Operating Modes

The unit has 3 main modes: Auto, VPP or Timed mode. The default is VPP mode, most units should be configured as Auto mode. The Auto mode includes on-grid and off-grid functions. By default the Anti-backflow function is enabled.

A. On Grid Functionality

1. Anti-backflow function enabled:

In Auto Mode – the unit can provide power from the Grid and EPS terminals to any loads (max 2500W). When anti-backflow is enabled, the unit will not send power back to the grid. In VPP mode: RX-2505AC works as per the commands sent from the cloud platform. The unit can be fully customised with charging times and discharging times and set power levels in Timed mode.

2. Anti-backflow function disabled:

In Auto Mode – the unit can provide power from the Grid and EPS terminals to any loads (max 2500W). When the system detects that there is excess power available from solar and not being used by the loads and the battery is full, then power can be sent to the grid. In VPP mode: RX-2505AC works as per the commands sent from the cloud platform. The unit can be fully customised with charging times and discharging times and set power levels in Timed mode.

B. Off - Grid Functionality

When the power grid is cut off, the system will automatically switch to off-grid mode. The system will supply power to the load from the battery via the EPS terminals. Note: in off-grid mode, the maximum system output power is 2500W, meaning the load power of the EPS circuit should not exceed 2500W;

When the system detects a low battery status, the battery will stop discharging automatically and will be charged if there is solar or other power supplied.

• 6.3.2 Fault State

The RX-2505AC has a smart control system that continuously monitors and reports system status. When there is a system or equipment fault, fault information will be displayed on the web page /APP, and the LED light will also be on in fault mode.

Notes:

1. For details about fault information, see Chapter 9.
2. The fault details inform users of internal faults' possible reasons and rectifications.

• 6.3.3 Firmware Update

When the system is upgrading firmware, do not power off the unit. When the upgrade is complete, the system will automatically revert to normal working mode.

• 6.3.4 Self - Check Status

Before entering normal operation mode, RX-2505AC will enter self - check mode. If all checks pass successfully, the system will return to normal working mode; otherwise, the system goes into the fault state.

• 6.3.5 Standby Status

When the system does not fault, but certain operating conditions are not met, the system will go into standby mode.

• 6.3.6 Protection Mode

Connecting an over size load to the EPS terminal will trip the unit and trigger protection mode. The unit will try to restart 3 times, if the load is still present, the unit will revert to protection mode. Remove the over size load and restart the unit. If any circuit breakers have tripped – contact your installation partner.

• 6.3.7 Shutdown Status

Disconnect power supply and the system will automatically convert to standby mode. To shut down the unit, follow the specific steps below:

1. Turn off the power button.
2. Turn off the battery switch.
3. Disconnect the grid supply, the LED light and the battery power display LED light will be turned off.

Note: After all the above steps are completed, wait at least 5 minutes before performing other operations

• 6.4 Communication

The system has an external USB interface, which contains 5V power supply and RS485 communication. The Redx unit has a built-in data collector. Users can choose to connect their own data collector (WIFI / 4G function) according to their requirements, and use the computer or mobile phone APP (Redx Power) to monitor the machine. The default built-in datalogger in the device uses Wi-Fi to connect to the customer's Wi-Fi router to establish an Internet connection. The installer will connect the datalogger to the local Wi-Fi router during the installation process.

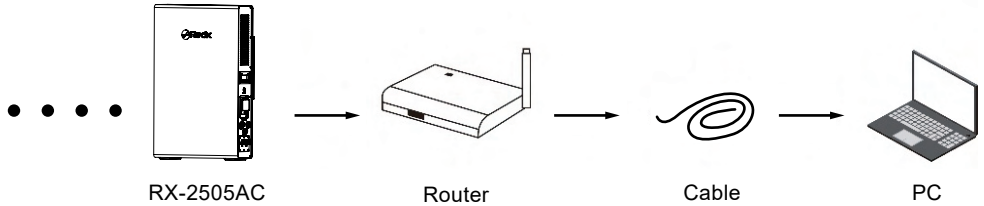

Figure 6-3 - Network diagram

• 7 RX - 2505AC System Turn on and Turn off

• 7.1 Turn on RX - 2505AC System

You can perform the following steps to start the RX - 2505AC:

1. Connect to the grid.
2. Turn on the battery circuit breaker.
3. Turn on the power button.
4. When the LED display is normal, the system starts normally.

• 7.2 Turn off RX - 2505AC system

1. Turn off the inverter power button.
2. Turn off the battery circuit breaker.
3. Turn off the AC circuit breaker.
4. When the LED display is off, the system is completely off.

• 8 Troubleshooting & Maintenance

• 8.1 Troubleshooting

Once a fault occurs in the storage unit, the fault information will be displayed on the APP/web interface.

Common Fault and Information below:

Table 8-1 – Fault information table 1

Fault information	Fault reason	Suggestion
The battery connection error	No battery is detected	If the battery is connected 1. Check whether the battery cable is securely connected and whether the battery voltage is normal. 2. If the error message remains, contact installation partner.
Battery under voltage or over voltage	If the battery voltage is abnormal, the internal circuit protection is triggered	1. Check whether the battery is correctly connected and whether the battery voltage is normal. 2. Make sure the battery is in good condition and restart the module. 3. If the error message remains, contact installation partner.
No grid	No grid is detected	If the grid is connected 1. Check whether the grid terminal is firmly connected and the grid voltage is normal; 2. If the error message remains, contact installation partner.
DC Bus under-voltage	The input is suddenly disconnected	1. When the fault is recovered, the inverter will automatically return to normal working state; 2. If the external environment does not change and the alarm remains after the system is restarted, contact installation partner.
DC Bus over-voltage	The rapid change of power grid voltage may cause high energy input to the inverter. Internal dc-dc converter or charging electronics may have a fault.	1. After the fault error is recovered, the inverter automatically restores to the normal working state. 2. If the fault remains, contact installation partner.
Inverter overvoltage	The output voltage of the inverter is out of the range.	1. Check whether the external load exceeds the specification range of the inverter. After the fault is recovered, the inverter automatically recovers to the normal working state. 2. If the alarm is repeated, contact installation partner.
Inverter undervoltage		



Islanding protection	Islanding protection check	<ol style="list-style-type: none"> 1. Check whether the AC circuit breaker of the grid is disconnected and whether the connecting cables are securely connected. 2. Check whether the grid has power. 3. If all conditions are correct and the fault still occurs, contact installation partner.
Grid overvoltage	When the grid detects an error, the inverter automatically switches to the off-grid mode. When the error disappears, the inverter automatically resumes to the grid mode	<ol style="list-style-type: none"> 1. Check the grid voltage or frequency; If the power grid voltage or frequency exceeds the allowable range of converter protection parameters, please report to the power grid company. 2. If the power grid voltage or frequency is within the permissible range, contact the installation partner.
Grid under voltage		
Grid over frequency		
Grid under frequency		
Battery over current	The charge and discharge current of the battery is too high	<ol style="list-style-type: none"> 1. Check whether the battery voltage and capacity exceed the allowable range of the inverter. 2. If the alarm is repeated, contact installation partner.
Relay fault	Detect the fault of relay	<ol style="list-style-type: none"> 1. Wait for the inverter to recover automatically. 2. If the alarm is repeated, contact installation partner.
Bus soft start failed	Bus voltage setup timeout	<ol style="list-style-type: none"> 1. Wait for the inverter to recover automatically. 2. If the alarm is repeated, contact installation partner.
The inverter soft start failed	Inverter output setup timeout	
Inverter phase lock failure	Inverter phase lock fault	<ol style="list-style-type: none"> 1. Wait for the inverter to recover automatically. 2. If the alarm is repeated, contact installation partner.
EEPROM read failure	EEPROM read fault	<ol style="list-style-type: none"> 1. Disconnect power and restart the system; 2. If the error remains, contact installation partner.
Fan fault	The fan is faulty	<ol style="list-style-type: none"> 1. Check whether the fan runs properly. Power off to restart the module; 2. If the error message still exists, contact installation partner.
The grid is connected to the EPS terminals	The AC input and load output cables are incorrectly connected	<ol style="list-style-type: none"> 1. Shut down the inverter and turn off all circuit breakers. 2. Check whether the AC input cable (power grid cable) is connected to the load (EPS) output terminal. If the connection is incorrect, reconnect the cable. 3. If the error message persists, contact installation partner.

Table 8-3 – Fault information table 3

Output overload	Overloaded outputs	<ol style="list-style-type: none"> 1. Remove some loads. Ensure that the load is smaller than the maximum output power of the inverter. 2. Restart the inverter.
Components overtemperature	<ol style="list-style-type: none"> 1. The inverter installation location is not ventilated. 2. The ambient temperature is too high. 3. The fan is faulty. 	<ol style="list-style-type: none"> 1. Check whether the operating environment exceeds the operating temperature range of the inverter. If yes, improve the operating environment. 2. Check whether the fan is in good condition.
The communication between the host computer is error	<ol style="list-style-type: none"> 1. The address and baud rate are incorrectly set. 2. The communication cable is loose. 	<ol style="list-style-type: none"> 1. Check the communication address and baud rate Settings (please change the baud rate to 2400). 2. Check whether the communication cable is loose. 3. Contact installation partner.
DSP communication error		
Grid Short Circuit	The AC input is short circuit.	<ol style="list-style-type: none"> 1. Check whether the AC input cable of the inverter is short-circuited. 2. If the error message persists, contact installation partner.
Load short circuit	Output short circuit.	<ol style="list-style-type: none"> 1. Remove load. 2. Restart system.

• 8.2 Maintenance

Table 8-4 – Maintenance warnings

	Danger!
	<p>RX-2505AC has lithium battery inside. Please pay attention to the following instructions</p> <ul style="list-style-type: none"> • Do not place RX-2505AC near fire, there may be risk of explosion. • Do not open RX-2505AC, without permission. • The battery has the hazard of electric shock or short circuit current. • Battery maintenance is to be performed by service personnel only.
	Danger!
	<p>Please read carefully the following items before installation:</p> <ol style="list-style-type: none"> 1. Remove watches, rings or other metallic objects. 2. Use tools with insulated handles. 3. Wear rubber gloves and insulated shoes.

• 8.3 Routine Maintenance

Table 8-5 – Maintenance list

Item	Method	Period
System Clean	Check the temperature and dust of the Storage Unit. Clean the unit enclosure if necessary.	Six Months to a year
Cable Entry	Check whether the cable entry is insufficiently sealed or the gap is excessively large; and reseal the entry when necessary.	Once a year
Electrical Connection	Check whether all cables are firmly in place. Check whether a cable is damaged (rodents. Physical damage, weather etc).	Once a year

• 9 Redx Power App

The Redx Power APP can establish communication connection to the energy storage unit via WIFI and or 4G (optional) network. Users can use the APP to view basic information, alarms, events, set parameters or download logs etc. The APP manual can be found on redxenergy.com.au/downloads

Note : Install the APP or open web page according to the attached instructions, and then configure the WIFI connection. The last page of the manual has a QR code to install the App.

• 10 Quality Assurance

When a product faults during the warranty period REDX will repair or provide a replacement product.

Evidence

During the warranty period, the customer must keep and provide the product purchase invoice and date. The user must provide proof of fault – pictures or videos with timestamps if requested by Redx.

From the date of purchase by the user from Redx (hereinafter referred to as the manufacturer), the user will enjoy the following after-sales warranty service:

1. A 7-year warranty commences from the date of shipment, during the warranty period the company provides free repair or replacement of product.
2. Any paid service (extended warranty) is available from the date of shipment from manufacturer.
3. Disclaimer: Product faults caused by the following reasons are not within the scope of the manufacturer's 7 years warranty commitment:
 - (a) The user does not perform the correct installation or operation according to the procedures listed in the product specification.
 - (b) Repairing the product without communicating with the manufacturer or changes the product without permission, resulting in product failure.
 - (c) Users not following the standards.
 - (d) The fault of the module caused by unsuitable environment.
 - (e) Fault due to earthquake, fire, natural disaster, lightning strike, war, solar flare, abnormal voltage rise, ionising radiation or other natural disasters caused by external factors.
 - (f) Outdoor installation of the unit will be considered a breach of the manufacturer's warranty.
4. Under the following circumstances, the manufacturer has the right not to provide warranty service:
 - (a) Brand, trademark, serial number, nameplate or other markings applied by the manufacturer in the product are damaged or cannot be identified.
 - (b) The customer fails to pay off the products according to the Purchase and Sales Contract signed by both parties.
 - (c) The user intentionally conceals the improper use of the product during installation, wiring, operation, maintenance or other processes to the after-sales service provider of the manufacturer.

*Redx reserves the right to change the contents of this specification and product performance without informing users.

• 11 Appendix

• 11.1 Product Specification

Table 11-1 – Product specifications table 1

Model	RX - 2505PW
Battery Capacity	4.8kWh
Nominal voltage	48Vdc
Voltage range	42Vdc - 54Vdc
Battery type	LFP
Max charging power	1500W
Max charging current	30A
Max discharging current	70 A
DOD (%)	90%
Grid	
Nominal grid voltage	230Vac
Grid voltage range	180Vac - 260Vac
Rated grid frequency	50 Hz
Grid frequency range	50 ± 5 Hz
Rated grid connection current	10.8A
Rated apparent power	2500VA
Max grid input current	22A
Power factor	0.8leading ~ 0.8 lagging
Total THD	<3%

Table 11-2 – Product specifications table 2

Phase type	Single Phase
Current (inrush)	<1A
Maximum output fault current	55Apeak/0.1ms
Maximum output overcurrent protection	20A
Off - Grid (EPS)	
Rated apparent power	2500VA
Nominal output power voltage	230 Vac
Nominal output power current	10.8A
Nominal output power frequency	50 Hz
Power factor range	>0.9
DC1 / DC2	
Rated Voltage	48V
Input Current Max	25A / 25A
Efficiency	
Max charging efficiency	94%
Max discharging efficiency	96%
System	
IP Rating	IP32
Operating temperature range (charging) / (discharging)	0°C~50°C / -20°C~50°C
Environment temperature range	-20°C~45°C
Relative humidity	10%~100%
Cooling	Air cooling
Acoustic Noise	40dB
Max Altitude	2000m
Inverter topology	Isolated
Overvoltage category	AC: III. DC: II
Active anti-islanding method	Reactive disturbance
The decisive voltage class	AC: DVC C; Other ports: DVC A
DC/DC topology	High frequency transformer
Communication	Modbus-RTU/Modbus-TCP, CAN2.0B, TCP/IP, WIFI
Communication medium	RS485 / CAN / WIFI / 4G
Weight	75Kg
Dimension (L/W/H)	900mm*600mm*140mm
Warranty	7 Years
Certificates and approvals	AS4777.2, IEC-62040-1, IEC62109-1&2

Table 11-3 – Product protections

Islanding protection	YES
Anti - backflow	YES
DC reverse connection protection	YES
AC output short circuit protection	YES
Over-frequency and under-frequency protectio	YES
Overvoltage or undervoltage protection	YES
DC fuse (battery side)	YES
Overcurrent protection (including battery overcurrent)	YES
over - temperature protection	YES

Table 11-4 - DC Ratings

Rated insulation voltage	1000V
Rated impulse withstand voltage	6000V
Suitability for isolation	YES
Rated operational current	100A
Rated short-time withstand current (I _{cw})	7.5KA
Rated short-circuit making capacity (I _{cm})	10KA
Rated breaking capacity	10KA

• **11.2 Optional Accessories**

The following table lists the optional accessories of the system, contact the manufacturer or distributor for further information

Table 11-5 - Accessories details

Name	Notes / Purpose
Data Collector	Data Collector (Wi-Fi)
Raspberry Pi	Bespoke VPP control
CT	Current Transformer
Smart Meter	Single phase smart meter

Note:

The anti-backflow function requires a smartmeter or a CT.

• 12 Contact

If you have any questions about our products, please contact our service hotline or dealers. please provide the following information when inquiring:

1. System serial number.
2. System model.
3. Fault code/Name.
4. Briefly describe the fault symptom.



For more information, please scan QR code above or log in directly
www.redxenergy.com.au



Download the Redx App with the above QR Code



Redx



Address: Unit 2/21 Millennium Circuit, Helensvale, QLD Australia 4212

Website: www.redxenergy.com.au

Email: info@redxenergy.com.au

Phone: 61 756729983

Specifications are subject to change without advance notice.