

Redx

User Manual

RX SERIES HYBRID INVERTER

Plus Series

RX-5006Plus/7006Plus

RX-5010Plus/7010Plus

RX-5013Plus/7013Plus

Redx

1
2
3
4
5
6

1

2

3

4

5

All Rights Reserved

No part of this document can be reproduced in any form or by any means without the prior written permission of Redx.

Trademarks

Redx and other Redx trademarks used in this manual are owned by Redx.

All other trademarks or registered trademarks mentioned in this document are owned by their respective owners.

Software Licenses

It is prohibited to use data confirmed in firmware or software developed by Redx, in part or in full, for commercial purposes by any means.

It is prohibited to perform reverse engineering, cracking, or any other operations that compromise the original program design of the software developed by Redx.

Contact Us

Redx Technology Australia Pty Ltd

Address: U2 / 21 Millennium Circuit, Helensvale, Australia 4212

Tel: +61 7 5672 9983

Email: info@redx.com.au

Website: www.redx.com.au

About This Manual

This manual mainly describes the product information, installation, operation, and maintenance guidelines of the Redx Hybrid inverter (RX-5006Plus/7006Plus/5010Plus/7010Plus/5013Plus/7013Plus). Please read this manual carefully before using this product and store the manual in a safe place. Redx will not notify the user of any changes to this manual.

This manual applies to the RX-5006Plus/7006Plus/5010Plus/7010Plus/5013Plus/7013Plus Hybrid inverter. The inverter must be installed by a qualified/licensed technician electrical. We strongly recommend that installers read this manual carefully. The manual includes the guidance on product installation, troubleshooting, communication and other aspects

Contents

1 Safety	1
1.1 Important Safety Instructions	4
2 Product Introduction	4
2.1 System Diagram	4
2.2 Production Details	7
2.3 Led Indicator Panel and Switches	9
2.4 Technical Fata	11
2.5 Product Features	15
3 Installation	17
3.1 Installation Preparation	17
3.2 Installation Tools	18
4 Installation Guide	19
4.1 Mounting Guid	19
5 Electrical Connection	20
5.1 Earth Connection	20
5.2 PV Connection	22
5.3 WiFi/4G Dongle	22
5.4 Communication Connection	23
5.5 Grid Connection	25
5.6 EPS Load/Generator Connection	26
6 Operation	27
6.1 Checklist Before Operation	27
6.2 Operation Checks	29
6.3 Operation Modes	29
7 RX-Plus Series System Turn On and Turn Off	31
7.1 Turn on Plus Series	31
7.2 Turn off Plus Series	31
8 Troubleshooting & Maintenance	31
8.1 Troubleshooting	31
8.2 Maintenance	34
8.3 Routine Maintenance	35
9 Redx Power App	36
10 Quality Assurance	36
11 Appendix	37
11.1 Optional Accessories	37
12 Contact	38

1 Safety

1.1 Important Safety Instructions

The RX-5006Plus/7006Plus/5010Plus/7010Plus/5013Plus/7013Plus Hybrid inverter has been designed and tested strictly according to international safety regulations. Read all safety instructions carefully prior to any work and always observe them when working with the Hybrid inverter.

Incorrect Operation or Work May Cause:

- Injury or death to the operator or third party.
- Damage to the inverter and other property or third party.









Safety Instructions



- (a) Do not open the case as risk of electric shock
- (b) Maintenance should be carried out by a professional licensed technician
- (c) Read this manual before operating the system. Redx is not responsible for failure or loss arising out of improper operation.
- (d) All wiring, installation, commissioning, and other work should be done by a licensed technician
- (e) Install the EPS plug even if the EPS cable is not connected.
- (f) Ensure that the storage unit is not installed or used in the following locations:
 - Poorly ventilated room
 - Places with inflammable gases or corrosive materials and large amounts of dust
 - High or low Environment temperature (above 55°C or below -20°C), or high humidity (greater than 90%)
 - In direct sunlight or near heating equipment
 - Do not use anything to cover the inverter and battery

In case of fire, use dry powder fire extinguishers instead of liquid fire extinguishers.

All electrical connections are subject to the local grid safety regulations and the storage system should be reconnected to the grid under conditions of approval.

Table 1-1 - Warnings

	<p style="text-align: center;">Danger!</p> <p>Removal of any protection, incorrect use, incorrect installation, or incorrect operation may result in death/serious personal injury or device damage. Transportation, loading and unloading, installation, start-up and maintenance must be carried out by qualified or trained engineer/technician.</p>
 	<p style="text-align: center;">Danger!</p> <p>Before maintenance or touching any parts, or installation, make sure that the energy storage unit is disconnected and wait 5 minutes to ensure that the internal capacitor is discharged.</p>
	<p style="text-align: center;">Warning!</p> <p>Installation must be in full compliance with national and local laws and regulations.</p>
	<p style="text-align: center;">Warning!</p> <p>Ensure that the system is positioned correctly and is not allowed to roll sideways or upside down.</p>
	<p style="text-align: center;">Warning!</p> <p>Do not change the internal circuit of the machine without permission.</p>
	<p style="text-align: center;">Warning!</p> <p>Before connecting to the grid, system the must be connected to the Ground. Follow the instructions. Improper operation may cause serious damage.</p>
	<p style="text-align: center;">Notice!</p> <p>There is a 4G/WIFI device connecting to the inverter, do not place the system in an environment where there is no 4G/WIFI signal.</p>

	<p style="text-align: center;">Warning!</p> <p>The product is not tested to section 5 of AS/NZS 4777.2:2020 and is not to be used in multiple inverter combinations without additional considerations by the system designer</p>
	<p style="text-align: center;">Warning!</p> <p>The load capacity of the output of the inverter load is as follows: Inductive load (such as air conditioning, washing machine, motor, etc.). Single maximum power 3.5kVA, total inductive load maximum power 4.2kVA (with power grid); Capacitive load (e.g. computer, switching power supply, etc.). The maximum power of the total capacitive load is 3.5kVA (without power grid); The maximum power of the total capacitive load is 4.2KVA (with power grid).</p>
	<p style="text-align: center;">Warning!</p> <p>When installing the PV, install a circuit breaker between the PV and the inverter and between the inverter and the power grid according to local regulations.</p> <p>When the photovoltaic array is exposed to light, it supplies a DC voltage to the PCE. To ensure a safe work environment, keep the whole surface of the photovoltaic panel covered with opaque material to solar radiation before connecting panel to equipment.</p>

2 Product Introduction

2.1 System Diagram

The RX-5006Plus/7006Plus/5010Plus/7010Plus/5013Plus/7013Plus is a Hybrid inverter combined with PV and energy storage systems. It utilizes solar power and battery power to ensure continuous power supply even during a grid outage, the unused power can also be fed into the power grid. It also provides additional expansion ports and expansion ports for compatible connections.

Anti-Islanding Effect

Islanding effect is a special phenomenon that grid-connected PV system still supply power to the nearby grid when the voltage loss is happened in the power system. It is dangerous for maintenance personnel and the public. RX-5006Plus/7006Plus/5010Plus/7010Plus/5013Plus/7013Plus inverter provide Island Active Disturbance to prevent islanding effect.

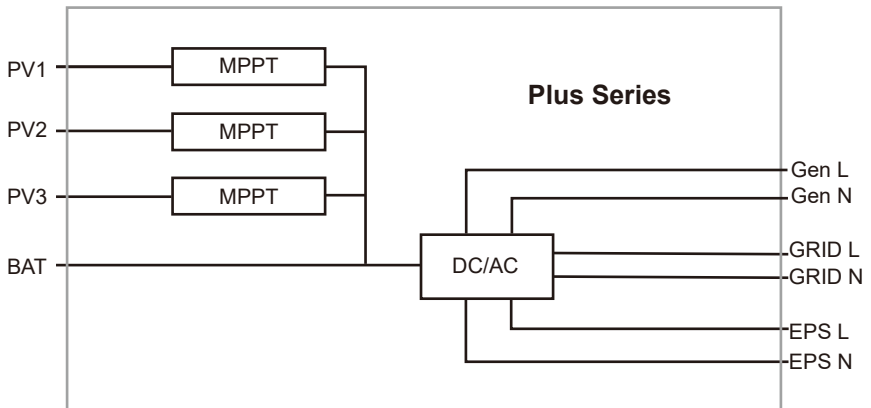

Figure 2.1.1 - The internal system diagram

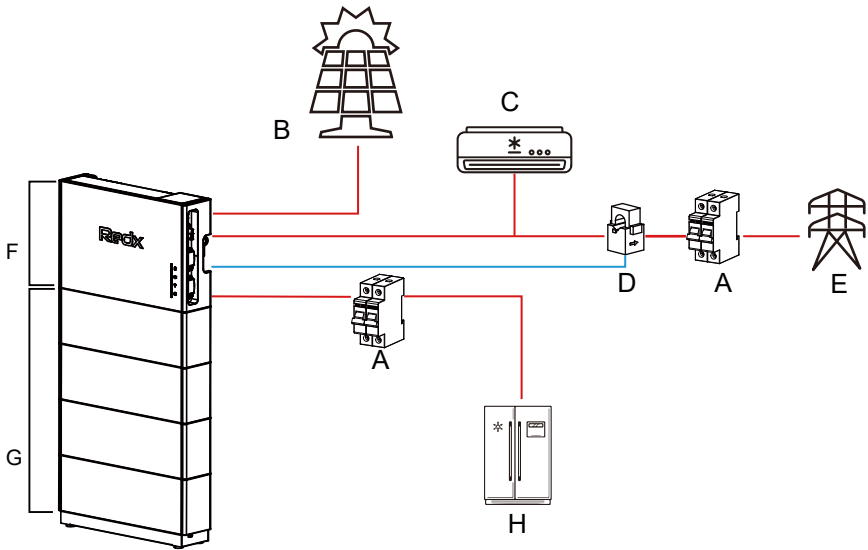

Figure 2.1.2 The Plus Series application

—Red indicates a power cable, —Blue indicates a signal cable
 The explanation is as follows:

Table 2.1.2 - Diagram elements explained

Number	Name
A	Circuit Breaker
B	PV Panel
C	Regular Loads
D	Smartmeter / CT
E	Grid
F	Plus Series Hybrid Inverter
G	Four Battery Modules
H	Backup Loads

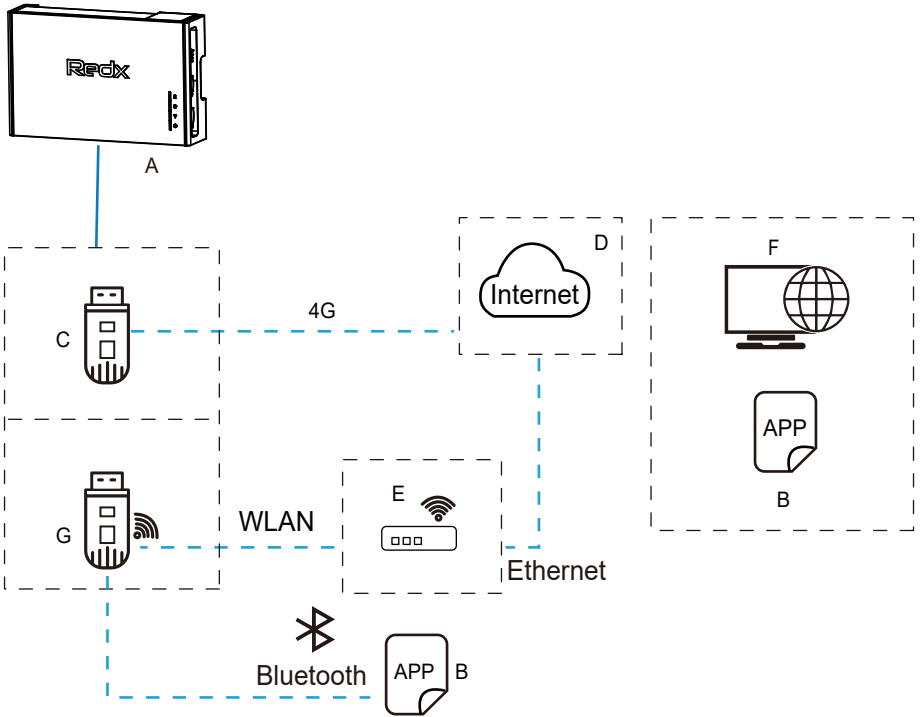

Figure 2.1.3 The communication components (dashed boxes indicate optional components) of the Plus Series Hybrid inverter.

— Blue indicates a signal cable, - - - Blue hidden indicates wireless communication

The explanation is as follows:

Table 2.1.3 - Diagram elements explained

Number	Name
A	Plus Series Hybrid Inverter
B	Redx Power App
C	4G Module
D	Internet
E	Wi-Fi Router
F	Cloud Server
G	Wi-Fi Module

2.2 Production Details

2.2.1 Appearance and Dimensions

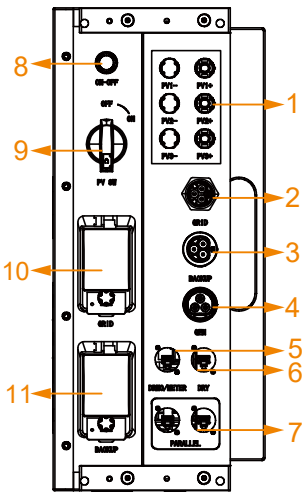
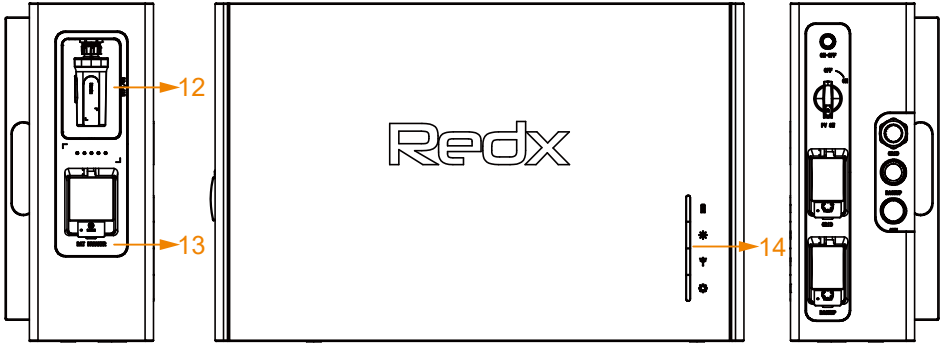

Items	Name
1	PV
2	GRID
3	BACKUP
4	GEN
5	DRMO / METER
6	DRY
7	PARALLEL
8	ON-OFF
9	PV SW
10	GRID BREAKER
11	BACKUP BREAKER
12	WIFI / 4G
13	BAT BREAKER
14	LED

Table 2.2.1 - Diagram elements explained

2.2.2 Dimension

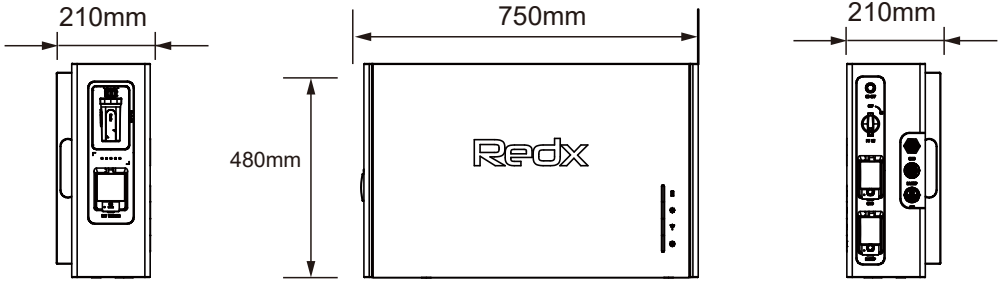

RX-5006Plus/7006Plus/5010Plus/7010Plus/5013Plus/7013Plus

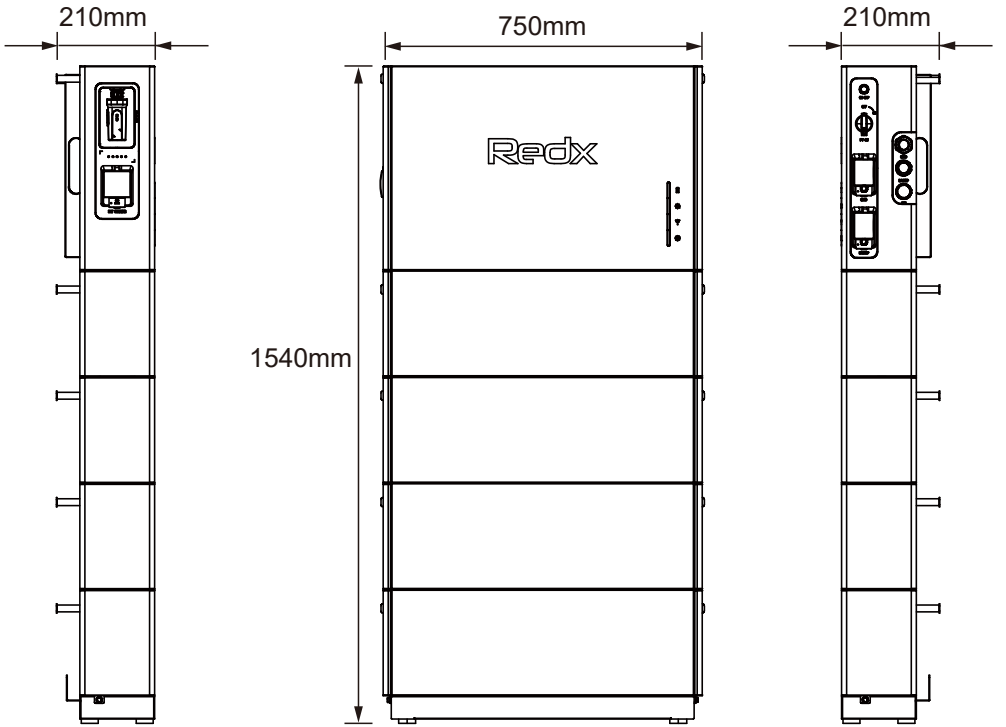

Figure 2.2.2 Plus Series Dimensions

2.3 LED Indicator Panel and Switches

Main power switch

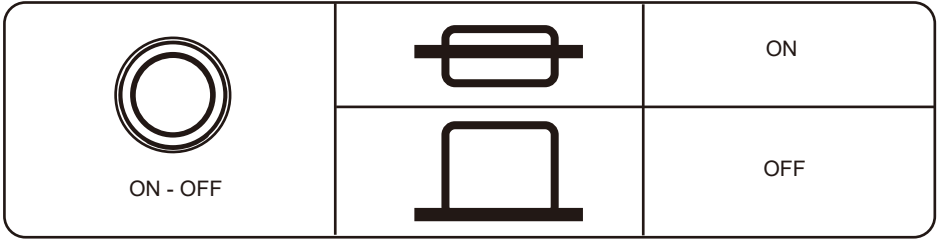





Figure 2.3.1 RX-5006Plus/7006Plus/5010Plus/7010Plus/5013Plus/7013Plus On-Off switch

Table 2.3.1 - Status LED elements explained

SOC Led Indicator					
Charging					
S0C	L1 ●	L2 ●	L3 ●	L4 ●	L5 ●
0-20%	flash	off	off	off	off
21-40%	on	flash	off	off	off
41-60%	on	on	flash	off	off
61-80%	on	on	on	flash	off
81-100%	on	on	on	on	flash
Normal					
S0C	L1 ●	L2 ●	L3 ●	L4 ●	L5 ●
0-20%	on	off	off	off	off
21-40%	on	on	off	off	off
41-60%	on	on	on	off	off
61-80%	on	on	on	on	off
81-100%	on	on	on	on	on

System Status	System Information	Display Logic			
		LED1 Battery	LED2 PV	LED3 Grid/Gen	Bi-colour
					LED4(Green/RED) Wifi/Ethernet/Fault 
Normal information	Power on	▲	▲	▲	▲
	Power off	■	■	■	■
	Promote update	/	/	/	★
	Promote update success	★	★	★	★
Battery	Battery not connected	■	/	/	■
	Battery connected & discharge	●	/	/	/
	Battery low(Battery connected & discharge)	★	/	/	/
	Battery charge	■	/	/	/
	Battery fault	■	/	/	●
PV	PV not connected	/	/	/	/
	PV connected & work	/	●	/	/
	PV fault	/	■	/	●
Grid-Generator	Grid-Generator not connected	/	/	/	/
	Grid-Generator connected & work	/	/	●	/
	Grid-Generator fault	/	/	■	●
External communication	Wifi-Ethernet not connected	/	/	/	■
	Wifi-Ethernet connecting	/	/	/	■
	Wifi-Ethernet success connect & work	/	/	/	●
Other important information	SOH low	/	/	/	■
	Permanent fault	■	■	■	■
	Idle	/	/	/	/
	System fault	/	/	/	●
<p>Remark:</p> <p>1、lamp-comment: / : LED off/LED ●/●/● : LED on/LED ■/■/■ : LED flash display-1Hz/LED-1Hz ★/★/★ : LED flash display-2Hz/LED-2Hz ▲/▲/▲ : LED light water display-2Hz/-2Hz</p> <p>2、LED1/LED2/LED3/LED4 are displayed independently of each other during normal operation, and their functions can be stacked. If a fault is triggered, display it according to the faulty part.</p>					

2.4 Technical Data

Figure 2.3.2 - RX-7000Plus Technical information

Items	Specifications		
Model:	RX-7006Plus	RX-7010Plus	RX-7013Plus
	<input type="text"/>	<input type="text"/>	<input type="text"/>
PV			
Max MPPT power	3kW/3kW/3kW(9kW)		
Quantity of MPPTs / MPPT	3		
Max. input voltage	550V		
MPPT voltage range / MPPT	120 ~ 500V		
MPPT voltage range (full load)	200V - 400V		
MPPT rated working voltage / MPPT	300V		
MPPT start voltage / MPPT	120V		
Max. input current	16A		
Short circuit current	20A		
Battery			
Battery type	LFP		
Modules	2	3	4
Nominal capacity	32.65Ah		
Rated capacity	30.85Ah		
Nominal energy	6.69kWh	10.03kWh	13.37kWh
Rated energy	6.32kWh	9.48kWh	12.64kWh
Nominal voltage	204.8V	307.2V	409.6V
Voltage rang	160 ~ 230.4V	240 ~ 345.6V	320 ~ 460.8V
Max.charge/discharge current	32Adc		
On - Grid			
Rated power	5kW	7kW	
Rated grid voltage	180V ~ 265Vac		
Rated grid current	22Aac	30.5Aac	
Grid frequency range	45 ~ 55Hz		
Power factor range	+0.8 to -0.8		
THDi	< 5%		
RCDs	Type B(30mA)		
Generator			
Rated input voltage	1P+N+PE, 230Va.c.		
Rated input frequency	50Hz		
Rated input current	22A	30.5A	
Rated input apparent power	5000VA	7000VA	

Off - grid Output

Rated output power	5kW	7kW	
Peak output power(PV+BAT)	5.5kVA / 10s	8KVA/10s	
Rated voltage	230V		
Rated current	22A	30.5A	
Frequency	50Hz ± 0.1Hz		
Back - up switch time	≤ 20ms		

Efficiency

Max. Efficiency between BAT and grid	96.6%	97%	96.8%
--------------------------------------	-------	-----	-------

General Data

Dimension(H*W*D) (with decoration panel)	1040*750*210mm	1290*750*210mm	1540*750*210mm
Weight	107kg	140.5kg	174kg
Noise emission	≤ 35dB		
Operating ambient temperature	-20 C ~ 55 C		
Storage temperature	-30 C ~ 60 C / 7day; -20 C ~ 45 C / 6 months; 5%~95%RH		
Operating ambient humidity	5%~95%		
Ingress Protection rate/IP	IP65		
Altitude	≤ 3000m		
Cooling	Natural cooling		
Cycle Life(25°C)	≥ 6000 cycle / 60%SOH		
Room Temperature Calendar Life(25°C)	10 years		
Phase	Single - phase		
Topology	Transformerless		
Monitoring	LED / APP		
Max parallel system	4		
Communication Port	WIFI / 4G		
Protective Class	Class I		
Decisive voltage class	AC, DC: DVC C, Other ports: DVC A		
PV array configuration	Not be functionally grounded		
Overvoltage category	AC: OVC III DC: OVC II Others: OVC I		
Active anti-islanding method	Reactive disturbance		

Certification

System Standard	IEC62619, IEC62040, IEC62109-1/2		
Grid Connection Standard	AS4777.2		
EMC Standard / EMC	IEC 61000-6-1 / 3		
Transportation Standard	UN38.3		
Environment protection standard	RoHS / REACH		
Other Standard	CEC List / CEC		

Figure 2.3.3 - RX-5000Plus Technical information

Items	Specifications		
Model:	RX-5006Plus <input type="text"/>	RX-5010Plus <input type="text"/>	RX-5013Plus <input type="text"/>
PV			
Max MPPT power	3kW/3kW/3kW(9kW)		
Quantity of MPPTs / MPPT	3		
Max. input voltage	550V		
MPPT voltage range / MPPT	120 ~ 500V		
MPPT voltage range (full load)	200V - 400V		
MPPT rated working voltage / MPPT	300V		
MPPT start voltage / MPPT	120V		
Max. input current	16A		
Short circuit current	20A		
Battery			
Battery type	LFP		
Modules	2	3	4
Nominal capacity	32.65Ah		
Rated capacity	30.85Ah		
Nominal energy	6.69kWh	10.03kWh	13.37kWh
Rated energy	6.32kWh	9.48kWh	12.64kWh
Nominal voltage	204.8V	307.2V	409.6V
Voltage rang	160 ~ 230.4V	240 ~ 345.6V	320 ~ 460.8V
Max.charge/discharge current	32A _{dc}		
On - Grid			
Rated power	5kW		
Rated grid voltage	180V ~ 265Vac		
Rated grid current	22A _{ac}		
Grid frequency range	45 ~ 55Hz		
Power factor range	+0.8 to -0.8		
THDi	< 5%		
RCDs	Type B(30mA)		
Generator			
Rated input voltage	1P+N+PE, 230Va.c.		
Rated input frequency	50Hz		
Rated input current	22A	30.5A	
Rated input apparent power	5000VA		

Off - grid Output

Rated output power	5kW
Peak output power(PV+BAT)	5.5kVA / 10s
Rated voltage	230V
Rated current	22A
Frequency	50Hz ± 0.1Hz
Back - up switch time	≤ 20ms

Efficiency

Max. Efficiency between BAT and grid	96.6%	97%	96.8%
--------------------------------------	-------	-----	-------

General Data

Dimension(H*W*D) (with decoration panel)	1040*750*210mm	1290*750*210mm	1540*750*210mm
Weight	107kg	140.5kg	174kg
Noise emission	≤ 35dB		
Operating ambient temperature	-20 C ~ 55 C		
Optimal operating temperature	15 C ~ 35 C		
Storage temperature	-30 C ~60 C / 7day; -20 C ~45 C / 6 months; 5%~95%RH		
Operating ambient humidity	5%~95%		
Ingress Protection rate/IP	IP65		
Altitude	≤ 3000m		
Cooling	Natural cooling		
Cycle Life(25°C)	≥ 6000 cycle / 60%SOH		
Room Temperature Calendar Life(25°C)	10 years		
Phase	Single - phase		
Topology	Transformerless		
Monitoring	LED / APP		
Max parallel system	4		
Communication Port	WIFI / 4G		
Protective Class	Class I		
Decisive voltage class	AC, DC: DVC C, Other ports: DVC A		
PV array configuration	Not be functionally grounded		
Overvoltage category	AC: OVC III DC: OVC II Others: OVC I		
Active anti-islanding method	Reactive disturbance		

Certification

System Standard	IEC62619, IEC62040, IEC62109-1/2
Grid Connection Standard	AS4777.2
EMC Standard / EMC	IEC 61000-6-1 / 3
Transportation Standard	UN38.3
Environment protection standard	RoHS / REACH
Other Standard	CEC List / CEC

2.5 Product Features

- a. Backup power supply
- b. Noiseless with no fan inside
- c. Compatible with various application scenarios
- d. Intelligent management
- e. Remote scheduling
- f. Multiple protection
- g. Stacked battery, no installation required
- h. Long product life without bus electrolytic capacitor

3 Installation

Storage

Store the storage unit properly when the unit is not installed immediately

- Store the unit in the original packaging box
- Storage temperature should be always between 0°C and 50°C+
- The packaging box should be upright.

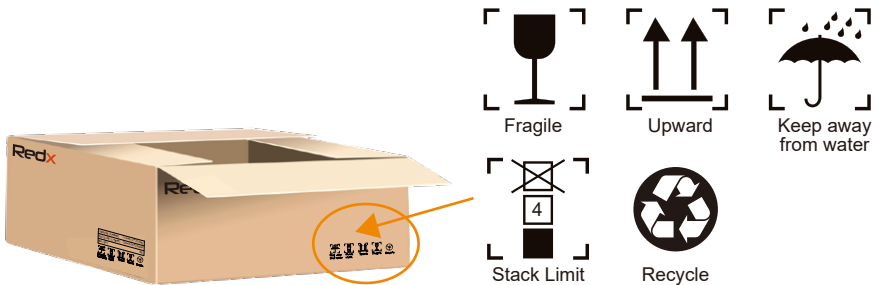

Figure 3.0.1 - RX-5006Plus/7006Plus/5010Plus/7010Plus/5013Plus/7013Plus packaging

Scope of Delivery

Please check the condition of the packing before unpacking. If any parts are damaged or missing, contact your local supplier for help.

RX-5006Plus/7006Plus/5010Plus/7010Plus/5013Plus/7013Plus Standard Accessories

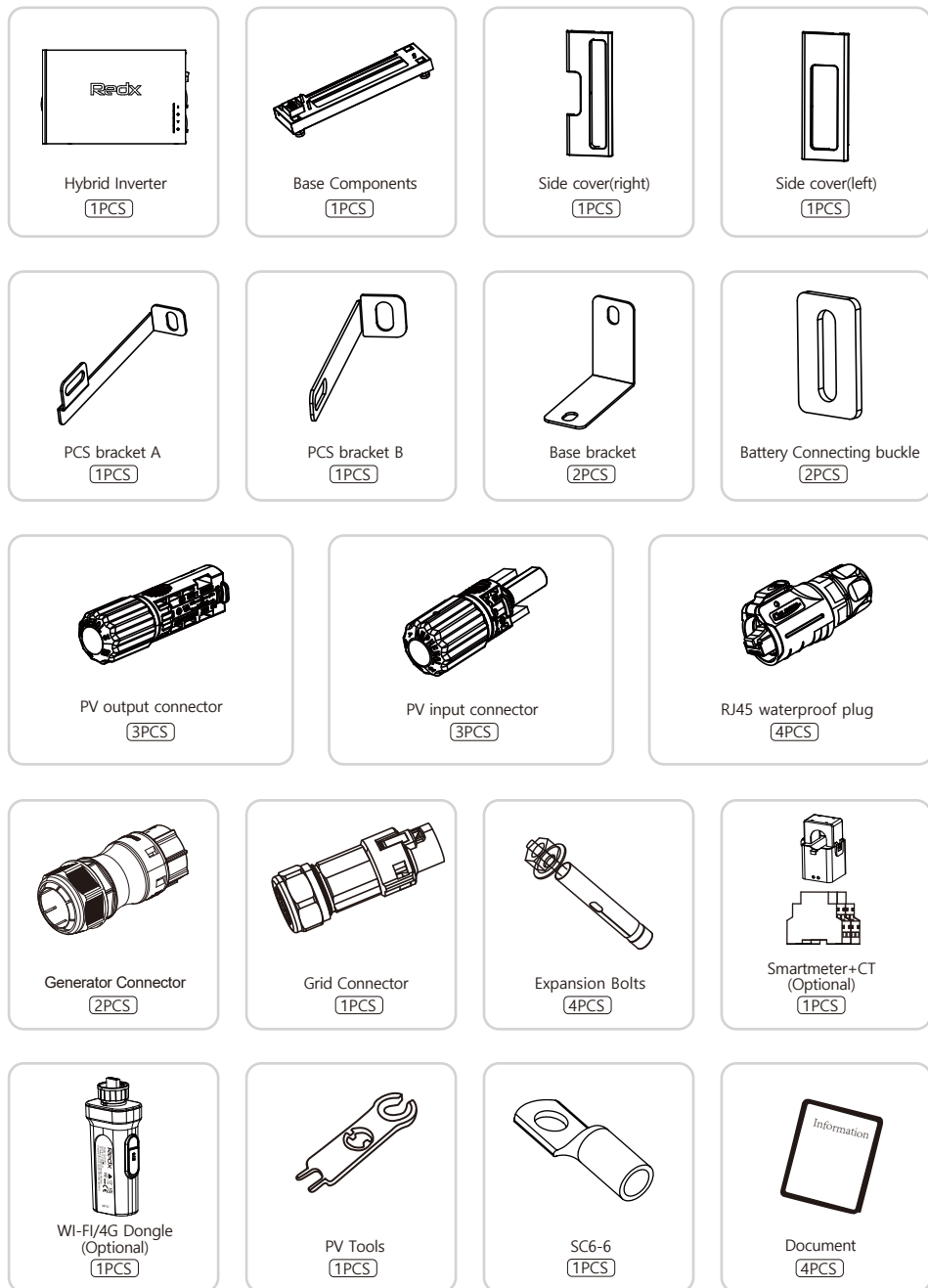

Figure 3.0.2 - RX-5006Plus/7006Plus/5010Plus/7010Plus/5013Plus/7013Plus components

3.1 Installation Preparation

- a. Not to be installed in direct sunlight. Vertical mounting only.
- b. Install in a ventilated location. There must be enough clearance to ensure that the module operates in the optimal heat dissipation state.
- c. Install at suitable distance from any restricted areas, please review Standard AS/NZS 5139:2019.
- d. Install on a sturdy supported surface.
- e. The location must fit the weight and size of the module.
- f. The environmental temperature must be between -20 °C to +55 °C, and the relative humidity between 0% and 90% (without condensation)
- g. Location shall be dry with adequate air flow (Pollution Degree < PD3) .
- h. Installation is prohibited in any of the following environments

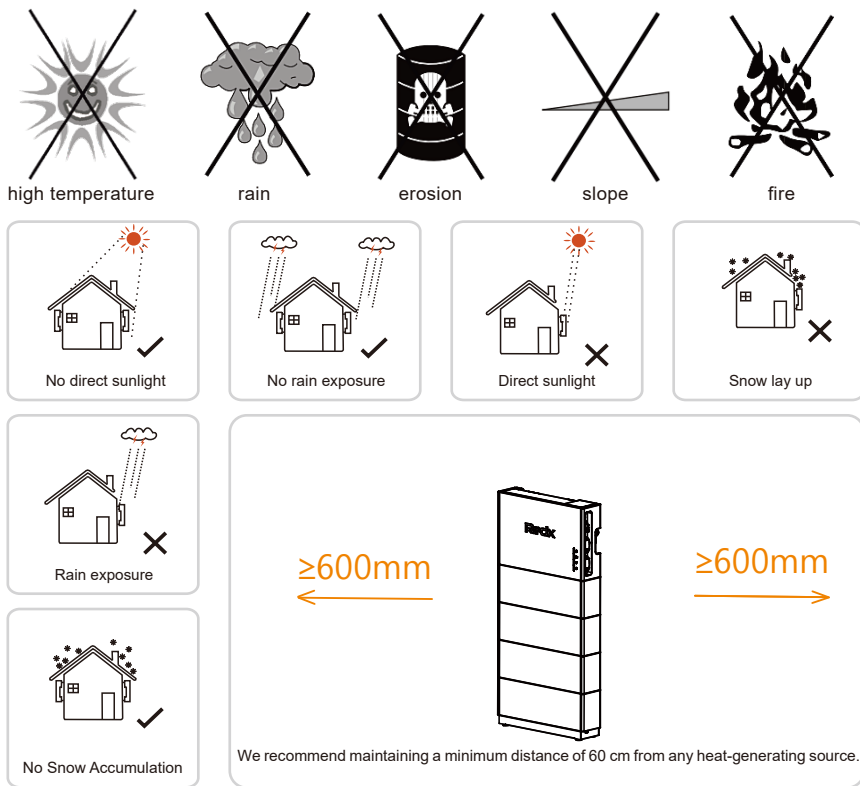





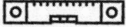

















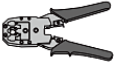

Figure 3.1.1 - RX-5006Plus/7006Plus/5010Plus/7010Plus/5013Plus/7013Plus Installation locations

- a. The minimum clearance on the sides must be maintained at least 600mm.
- b. Installation location of the inverter should be easy for operator to turn off at any time.
- c. Do not install the inverter near signal transmitters.
- d. Do not install the inverter in the living area.
- e. Do not install the inverter at location where children can easily access.

3.2 Installation Tools

Prepare the following tools before installation:

Figure 3.2.1 - RX-5006Plus/7006Plus/5010Plus/7010Plus/5013Plus/7013Plus Installation tools

Type	Tool			
General tools				
	Packaging tape	Marker	Measuring tape	Level
				
	Utility knife	Multimeter Measurement range: $\geq 1100\text{Vdc}$	Protective clothing	Wrist strap
				
Protective gloves	Dust mask	Earplugs	Goggles	
				
Insulated shoes	Vacuum cleaner			
Installation tools				
	Hammer drill bit	Rubber mallet	Slotted screwdriver	Phillips screwdriver Specification: M4, M6
				
	Wire stripper	Hydraulic clamp	Crimping pliers	Wire nippers
				
	Crystal head crimping pliers	Percussion drill	Square pliers	

4 Installation Guide

4.1 Physics Installation

Avoid water and electricity when drilling, bit size $\varnothing 8\text{mm}$, drilling depth 40mm.

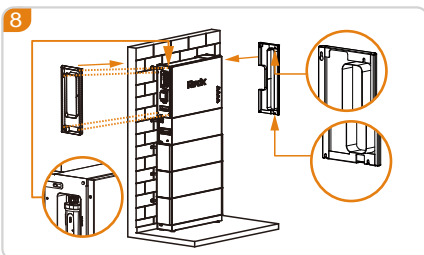
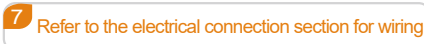
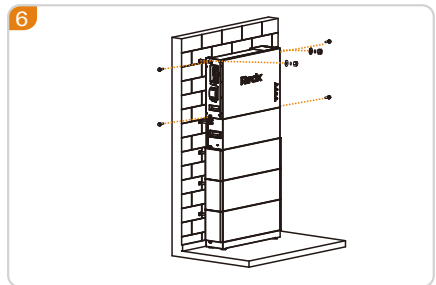
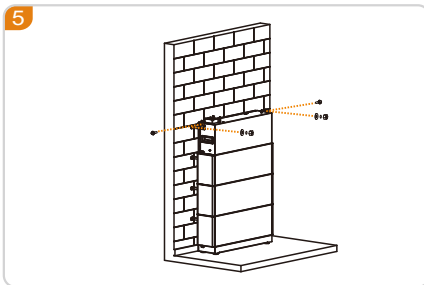
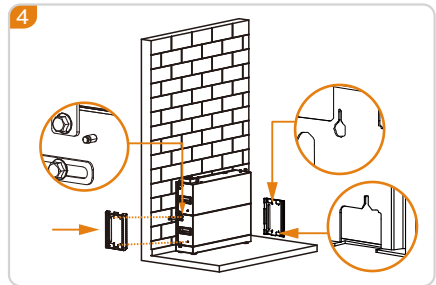
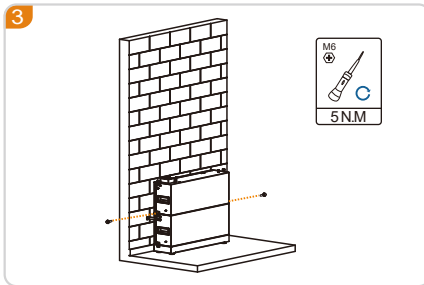
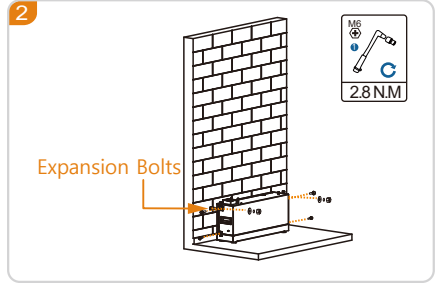
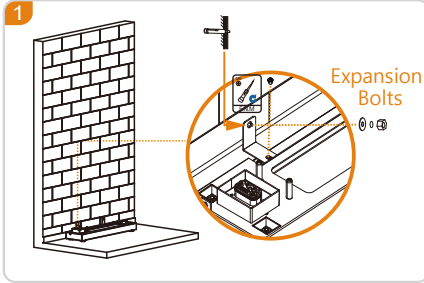

5 Electrical Connection



An independent circuit breaker must be configured for each power interface.

The table below is a recommendation for cable selection and the Recommended specifications of circuit breaker. Engineers should refer to local standards to select cables. Cable length is generally 2 to 10 meters, long cable will lead to voltage deviation from the rated value, consequently requiring an increase of the cross-sectional area.

Power interface	circuit breaker Suggestion	Cross-sectional area (mm ²)
LOAD	>32A	≥6 mm ²
GRID	>32A	≥6 mm ²
PV	>16A	≥4 mm ²
GENERAT	>32A	≥3.2 mm ²

Note: for details about the electrical connection, see Figure 2.1.2-2.1.3.

5.1 Earth Connection

A secondary protection grounding terminal is added for the system. Ensure that the grounding resistance is less than 10 Ω and the grounding cable diameter is greater than 6 mm².

PE Wiring

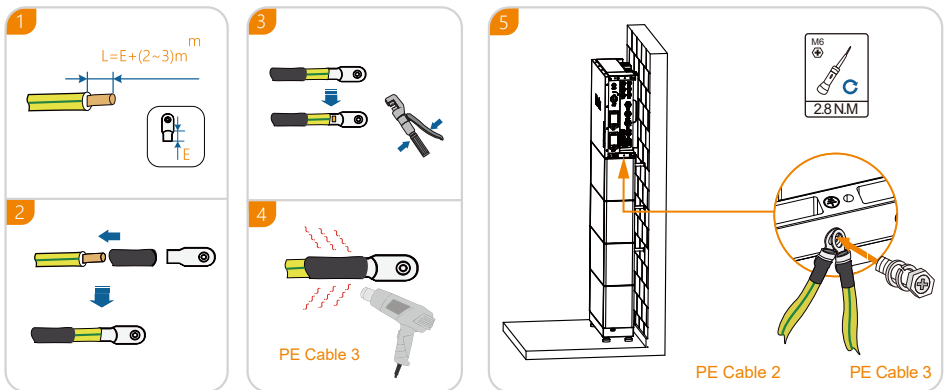

Figure 5.1.1 - RX-5006Plus/7006Plus/5010Plus/7010Plus/5013Plus/7013Plus Earthing connection

Note: If the array insulation resistance to ground is less than 18 K Ω , the inverter will turn on a red LED light Inspect and report ISO Fault on APP .This inverter complies with IEC 62109-2 clause 13.9 for earth fault alarm monitoring.

5.2 PV Connection



The RX-5006Plus/7006Plus/5010Plus/7010Plus/5013Plus/7013Plus is equipped with 3 independent MPPT (maximum power tracking) PV inputs, each MPPT with a maximum power of 3kW. Make sure the PV input open-circuit voltage does not exceed 550V. Generally, the open circuit voltage of PV is about 15% higher in winter (-20 C) than in summer (30 C).

Earth Fault Alarm

The inverter complies with IEC 62109-2 clause 13.9 for earth fault alarm monitoring.

If an Earth Fault Alarm occurs, the fault "IsoFault" will be displayed on the LCD screen, the red light will be on. and the fault can be found in the history of device fault log. Devices that are connected to the Internet with Wi-Fi/4G, the alarm information will be shown on the monitoring website www.redxpower.com, and also will be displayed in the Redx Power app.

PV Connection

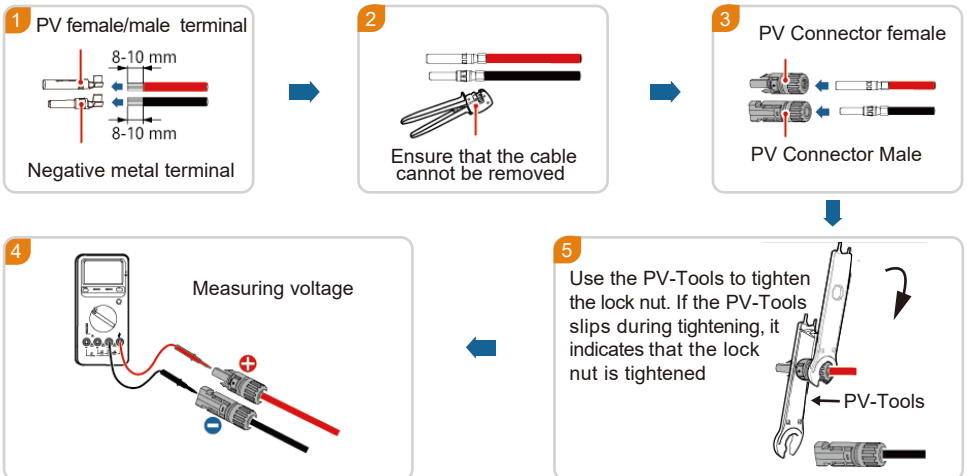

Figure 5.2.1 - PV connector

PV Arrays can be installed according to the needs of customers.

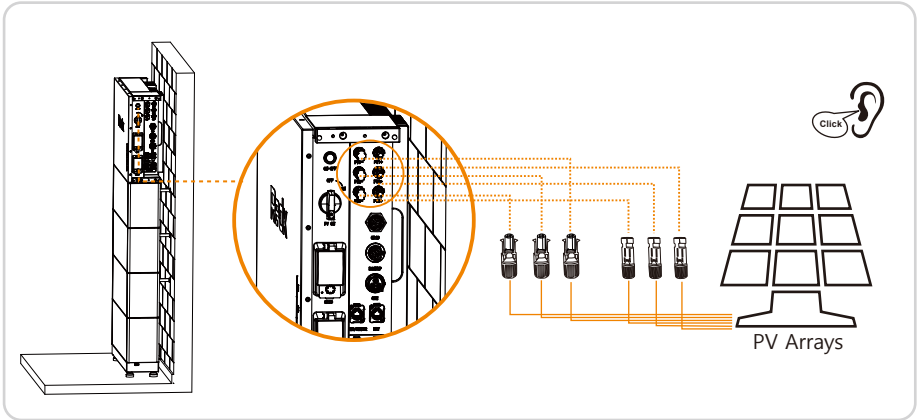
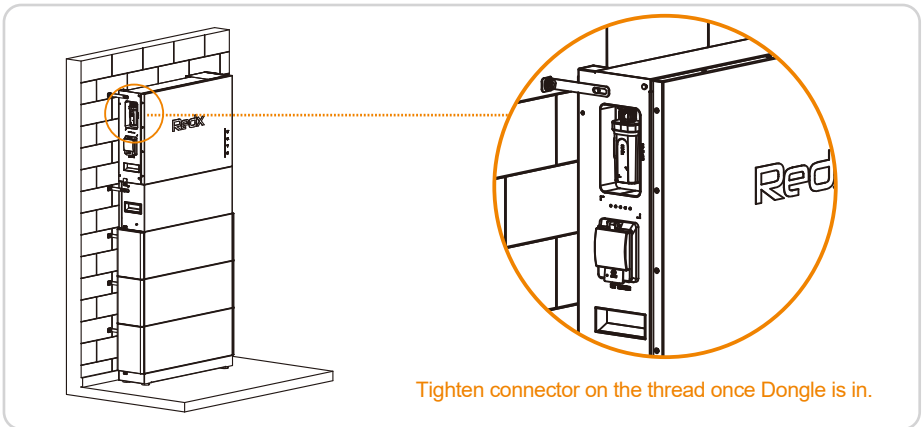
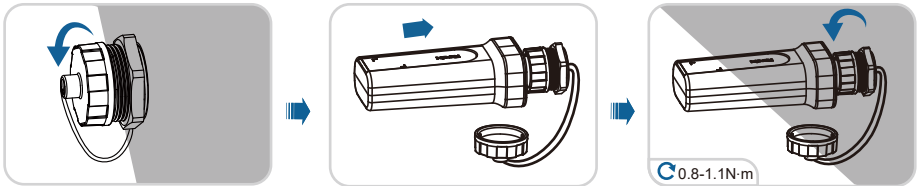
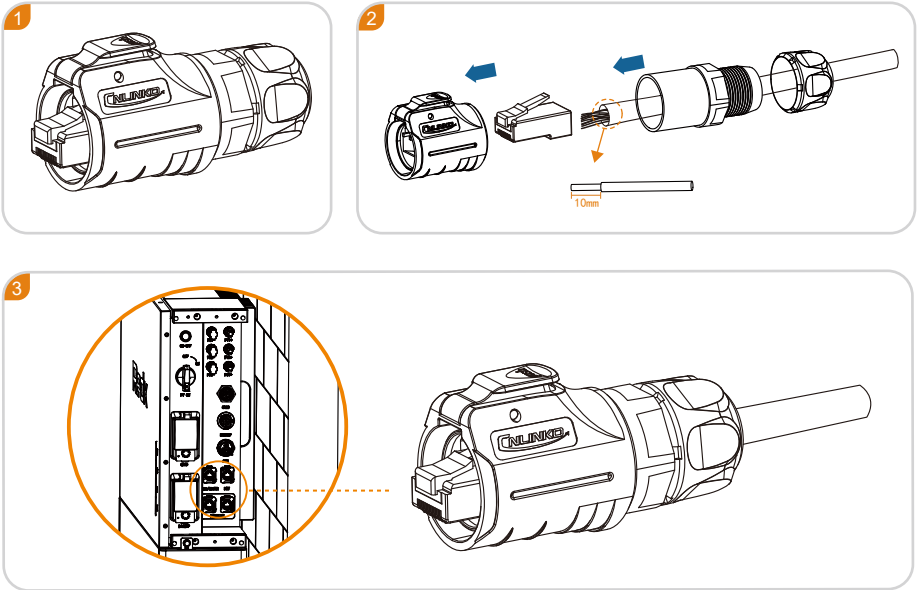

Figure 5.2.2 - RX-5006Plus/7006Plus/5010Plus/7010Plus/5013Plus/7013Plus PV connection

5.3 WiFi / 4G Dongle



5.4 Communication Connection



5.4.1 Dry Contact Connection

The dry contact is connected based on customer requirements. Dry nodes are used to control the start and stop of the generator.

Dry Contact		
Connect with weak current		
Pin	Group	Definition
1	A1	NC
2	A2	DRY_1_NC
3	A3	NC
4	A4	NC
5	A5	DRY_1_COM
6	A6	NC
7	A7	NC
8	A8	DRY_1_NO

RJ45

5.4.2 CT/METER/DRM0 Terminal Connection

The CT/METER is used to monitor the status of the energy consumption. When RX-5006Plus/7006Plus/5010Plus/7010Plus/5013Plus/7013Plus is installed in some states in Australia, the DRM0 terminal needs to be connected (Australia Only). The connection method is as follows:

CT / Smart meter / DRM0		
Smart meter 485,DRM0 signal, external CT		
Pin	Group	Definition
1	A1	I_CT_IN-
2	A2	I_CT_IN+
3	A3	485_C_A
4	A4	485_C_B
5	A5	DMR0-
6	A6	DMR0+
7	A7	Connect
8	A8	

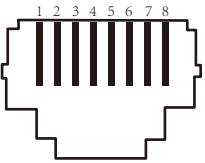

RJ45

CT cable specifications: if the cable is not long enough, adding an extension cable (max 10m), contact the local supplier in advance. The direction of CT installation as shown in Figure 5.5.2. The arrow direction on the CT must point to the power grid.

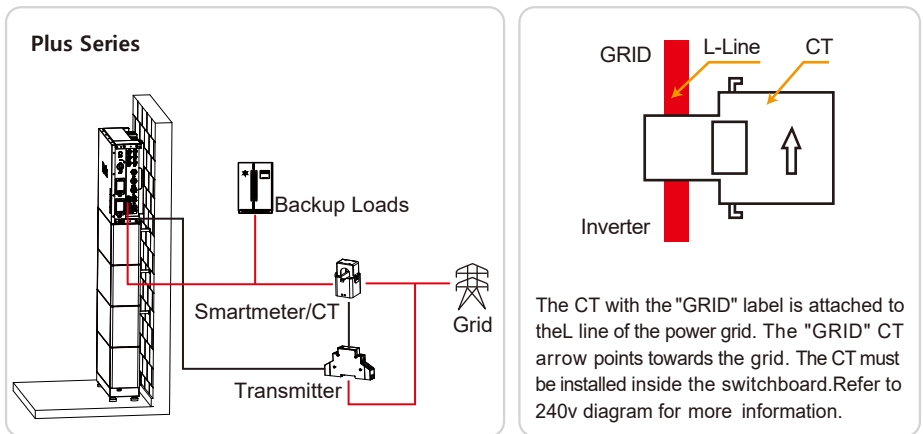
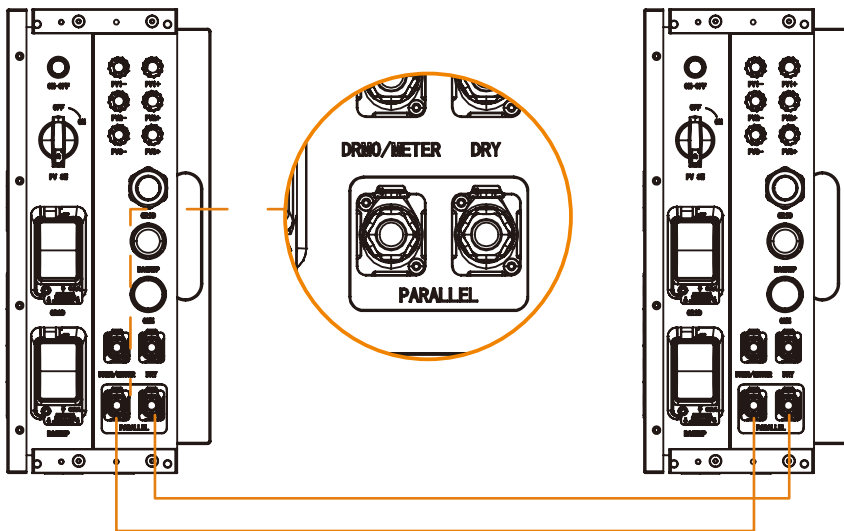

Figure 5.4.2



Network cable (8pin)

- ① The parallel function determines whether to install according to customer requirements
- ② The parallel ports are RJ45 terminals and are connected using conventional 8pin network cables

5.5 Grid Connection

Requirements

1. Install an AC circuit breaker between the inverter and the grid, before connecting the system to the grid.
2. Grid voltage and grid frequency should be within the allowable range of inverter operation.

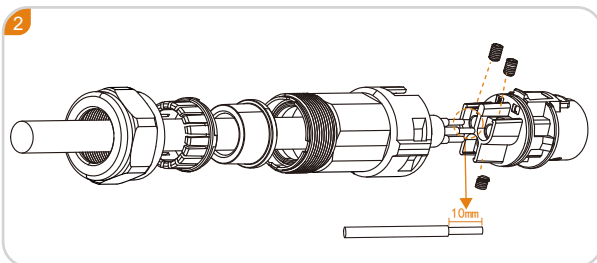
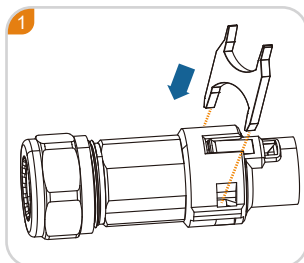

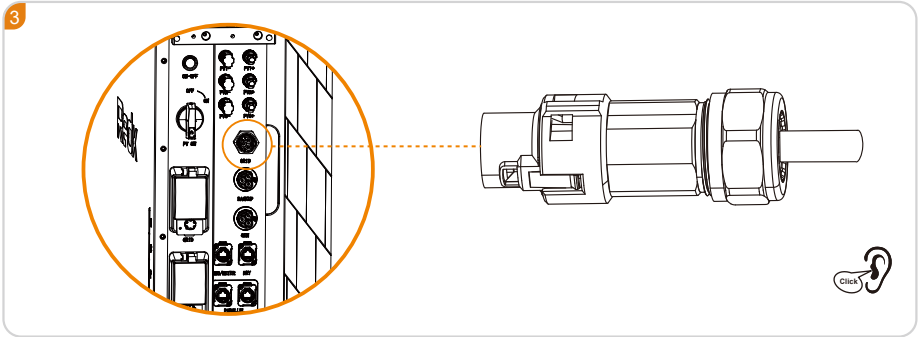
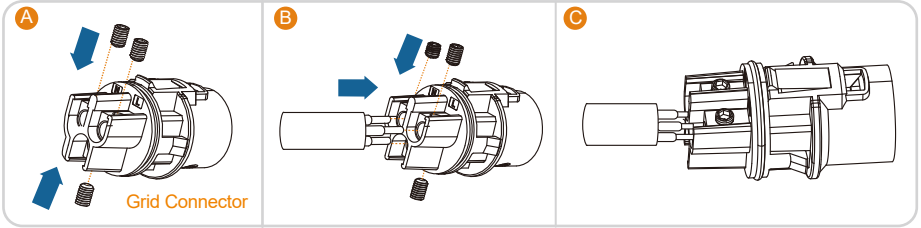

Note: for details about the electrical connection, see Figure 2.1.2-2.1.3.

1. The GRID terminal and off-grid (EPS LOAD) terminal cannot be connected together, otherwise the system will be damaged.
2. The battery needs to be activated by the grid when the system starts for the first time.

5.6 EPS Load / Generator Connection

Both grid neutral and eps neutral connect to main neutral bar

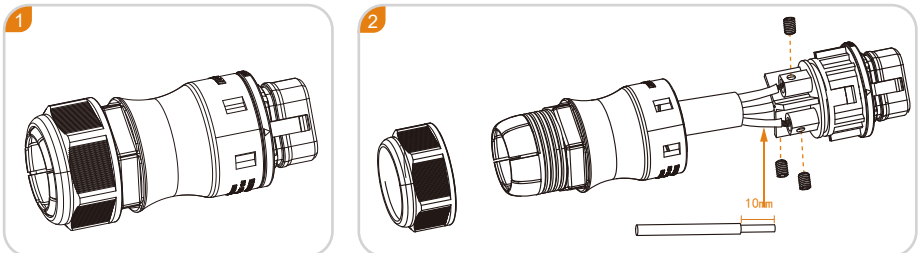

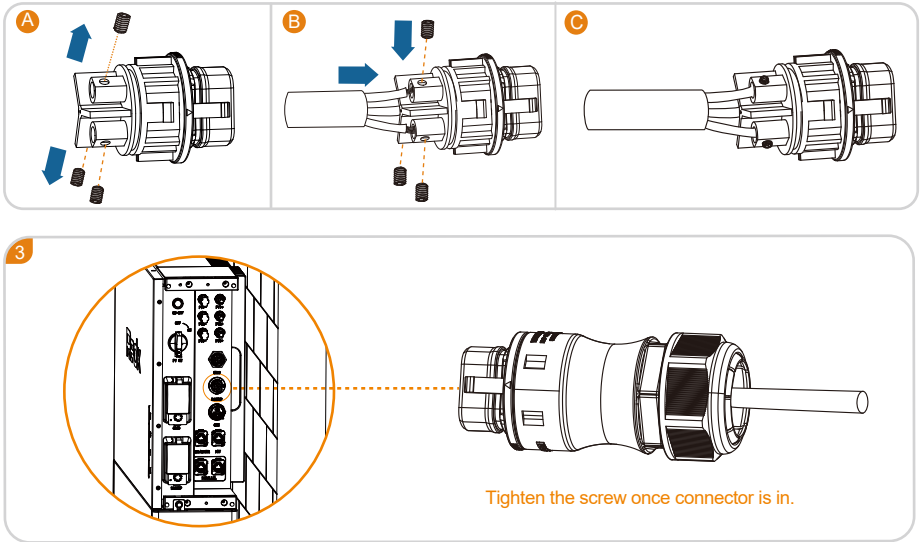

Figure 5.6.1 - RX-5006Plus/7006Plus/5010Plus/7010Plus/5013Plus/7013Plus EPS connector assembly



Do not connect the port to other power supplies. Otherwise, the inverter may be damaged, causing risks.

6 Operation

6.1 Checklist Before Operation

1. Check whether the system is firmly installed, and the installation position is easy for operation and maintenance.
2. All cables are correctly connected, properly distributed, and well protected, and no mechanical damage is caused.
3. The selection of AC circuit breakers is correct.
4. The wiring terminals are securely installed, and the vacant terminals are sealed.
5. All safety signs and warning labels on the system are firmly and clearly visible

6. The installer must select the correct regional settings for the inverter. The installer will be able to select the correct regional settings in the app during commissioning. Selecting the customer's relevant Grid Operator will automatically allocate the relevant Regional settings. Alternatively the installer can login to www.redxpower.com with their installer credentials. Then they must navigate to Devices page, find their device by typing in the device serial number in the search field, then click on the device serial number and select the correct region in the Deploy section. The installer can also edit the Generation and Export Limit Control Settings on the Deploy page.

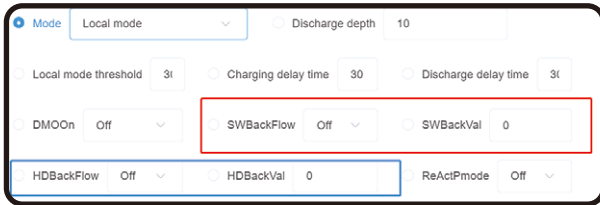

Figure 6-1 - Export Soft and Hard Limit settings on Deploy page

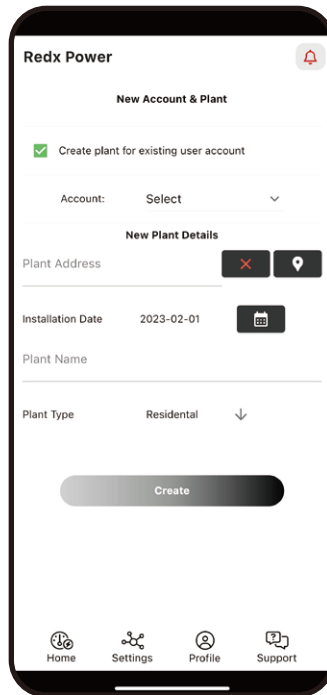

Figure 6-2- Region selector in the Redx Power App

Turning SWBackFlow and HDBackflow settings to "On" sets the soft export limit to the value of SWBackVal, and the hard export limit to the value of HDBackVal respectively. Turning both SWBackFlow and HDBackFlow parameters to "On" enables generation limit control to these values.

6.2 Operation Checks

1. Confirm that the above checklist meets the guideline.
 2. Turn on all circuit breakers
 3. After the AC circuit breaker is turned on and the LED on the system is on, perform the following tasks:
 - (a) If the LED indicator does not light up, check if voltage is present on grid input terminals. If there is voltage on the grid terminals, but unit is still not illuminating the LEDs– please contact local Redx dealer.
 - (b) Install the Redx Power APP or open web page according to the attached instructions, and then configure the WIFI connection.
 - (c) Turn on the battery circuit breaker on the side of the system.
 - (d) Turn on the PV circuit breaker on the side of the system.
 - (e) Turn on the Grid and EPS circuit breakers on the side of the system.
 - (f) Press the power button on the side of the system, then the system is in passthrough state and EPS port has output.
 - (g) Set the needed parameters through the web or APP. The battery LED indicator on the panel lights up, and the other LED indicators will light up according to the actual working status.
 - (h) If the operation fails, troubleshooting fault by referring to Chapter 8 in this manual
- Note: Use grid and the App to activate the battery for the first-time operation.

6.3 Operation Modes

6.3.1 Operating Modes

The unit has 3 main modes: Auto, VPP or Timed mode. The default is VPP mode, most units should be configured as Auto mode. The Auto mode includes on- grid and off-grid functions. By default the Anti - backflow function is enabled.

A. On Grid Functionality

1. Anti-backflow function enabled:

In Auto Mode – the unit can provide power from the Grid and EPS terminals to any loads (max 7000W). When anti-backflow is enabled, the unit will not send power back to the grid.

In VPP mode: RX-5006Plus/7006Plus/5010Plus/7010Plus/5013Plus/7013Plus works as per the commands sent from the cloud platform. The unit can be fully customised with charging times and discharging times and set power levels in Timed mode.

2. Anti-backflow function disabled:

In Auto Mode – the unit can provide power from the Grid and EPS terminals to any loads (max 7000W). When the system detects that there is excess power available from solar and not being used by the loads and the battery is full, then power can be sent to the grid. In VPP mode: RX-5006Plus/7006Plus/5010Plus/7010Plus/5013Plus/7013Plus works as per the commands sent from the cloud platform. The unit can be fully customised with charging times and discharging times and set power levels in Timed mode.

B. Off - Grid / EPS Functionality

When the power grid is cut off, the system will automatically switch to off-grid mode. The system will supply power to the load from the battery via the EPS terminals. Note: in off-grid mode, the maximum system output power using only the battery is 5000W, meaning the load power of the EPS circuit should not exceed 5000W. When PV and wind is supplying additional power in off-grid mode, the inverter maximum output is 7000W. When the system detects a low battery status, the battery will stop discharging automatically and will be charged if there is solar or other power supplied.

6.3.2 Fault State

The RX-5000 / 7000Plus has a smart control system that continuously monitors and regulates system status. When there is a system fault or equipment fault, fault information will be displayed on the web page /APP, and the LED light will also be on in fault mode.

Notes:

- (1) For details about fault information, see Chapter 9.
- (2) The fault details inform users of internal faults' possible reasons and rectifications.

6.3.3 Firmware Update

When the system is upgrading firmware, do not power off the unit. When the upgrade is complete, the system will automatically revert to normal working mode.

6.3.4 Self - check Status

Before entering normal operation mode, RX-5006Plus/7006Plus/5010Plus/7010Plus/5013Plus/7013Plus will enter self-check mode. If all checks pass successfully, the system will return to normal working mode; otherwise, the system goes into the fault state.

6.3.5 Standby Status

When the system does not fault but certain operating conditions are not met, the system will turn to standby mode.

6.3.6 Protection Mode

Connecting an oversize load to the EPS terminal will trip the unit and trigger protection mode. The unit will try to restart 3 times, if the load is still present, the unit will revert to protection mode. Remove the oversize load and restart the unit. If any circuit breakers have tripped – contact your installation partner.

6.3.7 Shutdown Status

Disconnect all power supply, turn everything off and the system will automatically enter the Off state. The specific steps are as follows:

1. Turn off the power button
2. Turn off the Pv button switch
3. Turn off the battery switch
4. Disconnect the grid supply, the LED light and the battery power display LED light will be turned off.

7 Plus Series System Turn On and Turn Off

7.1 Turn on Plus Series

You can perform the following steps to start the RX-5006Plus/7006Plus/5010Plus/7010Plus/5013Plus/7013Plus:

- (1) Connect to the grid.
- (2) Turn on the battery circuit breaker.
- (3) Turn on the PV circuit breaker.
- (4) Turn on the power button.
- (5) When the LED display is normal, the system starts normally.

7.2 Turn off Plus Series

- (1) Turn off the power button.
- (2) Turn off the battery circuit breaker.
- (3) Turn off the PV circuit breaker
- (4) Turn off the AC and all other circuit breaker.
- (5) When the LED display is off, the system is completely off.
- (6) Wait at least 60 seconds before performing further operations.

8 Troubleshooting & Maintenance

8.1 Troubleshooting



Once a fault occurs in the storage unit, the fault information will be displayed on the APP/web interface.

Fault information	Fault reason	Suggestion
The battery connection error	No battery is detected	Check whether the battery circuit breaker is on If the error message remains, contact installation partner.
Battery under voltage or over voltage	If the battery voltage is abnormal, the internal circuit protection is triggered	<ol style="list-style-type: none"> 1. Check whether the battery is correctly connected and whether the battery voltage is normal. 2. Make sure the battery is in good condition and restart the module. 3. If the error message remains, contact installation partner.
No grid	No grid is detected	<p>If the grid is connected</p> <ol style="list-style-type: none"> 1. Check whether the grid terminal is firmly connected and the grid voltage is normal; 2. If the error message remains, contact installation partner.
DC Bus under-voltage	The input is suddenly disconnected	<ol style="list-style-type: none"> 1. When the fault is recovered, the inverter will automatically return to normal working state; 2. If the external environment does not change and the alarm remains after the system is restarted, contact installation partner.
DC Bus over-voltage	The rapid change of power grid voltage may cause high energy input to the inverter. Internal dc-dc converter or charging electronics may have a fault.	<ol style="list-style-type: none"> 1. After the fault error is recovered, the inverter automatically restores to the normal working state. 2. If the fault remains, contact installation partner.
Inverter overvoltage	The output voltage of the inverter is out of the range.	<ol style="list-style-type: none"> 1. Check whether the external load exceeds the specification range of the inverter. After the fault is recovered, the inverter automatically recovers to the normal working state. 2. If the alarm is repeated, contact installation partner.
Inverter undervoltage		

Islanding protection	Islanding protection check	<ol style="list-style-type: none"> 1. Check whether the AC circuit breaker of the grid is disconnected and whether the connecting cables are securely connected. 2. Check whether the grid has power. 3. If all conditions are correct and the fault still occurs, contact installation partner.
Grid overvoltage	When the grid detects an error, the inverter automatically switches to the off-grid mode. When the error disappears, the inverter automatically resumes to the grid mode	<ol style="list-style-type: none"> 1. Check the grid voltage or frequency; If the power grid voltage or frequency exceeds the allowable range of converter protection parameters, please report to the power grid company. 2. If the power grid voltage or frequency is within the permissible range, contact the installation partner.
Grid under voltage		
Grid over frequency		
Grid under frequency		
Battery over current	The charge and discharge current of the battery is too high	<ol style="list-style-type: none"> 1. Check whether the battery voltage and capacity exceed the allowable range of the inverter. 2. If the alarm is repeated, contact installation partner.
Relay fault	Detect the fault of relay	<ol style="list-style-type: none"> 1. Wait for the inverter to recover automatically. 2. If the alarm is repeated, contact installation partner.
Bus soft start failed	Bus voltage setup timeout	<ol style="list-style-type: none"> 1. Wait for the inverter to recover automatically. 2. If the alarm is repeated, contact installation partner.
The inverter soft start failed	Inverter output setup timeout	
Inverter phase lock failure	Inverter phase lock fault	<ol style="list-style-type: none"> 1. Wait for the inverter to recover automatically. 2. If the alarm is repeated, contact installation partner.
EEPROM read failure	EEPROM read fault	<ol style="list-style-type: none"> 1. Disconnect power and restart the system; 2. If the error remains, contact installation partner.
The grid is connected to the EPS terminals	The AC input and load output cables are incorrectly connected	<ol style="list-style-type: none"> 1. Shut down the inverter and turn off all circuit breakers. 2. Check whether the AC input cable (power grid cable) is connected to the load (EPS) output terminal.If the connection is incorrect, reconnect the cable. 3. If the error message persists, contact installation partner.

Output overload	Overloaded outputs	<ol style="list-style-type: none"> 1. Remove some loads. Ensure that the load is smaller than the maximum output power of the inverter. 2. Restart the inverter.
Radiator over temperature	<ol style="list-style-type: none"> 1. The inverter installation location is not ventilated. 2. The ambient temperature is too high. 3. The fan is faulty. 	<ol style="list-style-type: none"> 1. Check whether the operating environment exceeds the operating temperature range of the inverter. If yes, improve the operating environment. 2. Check whether the fan is in good condition.
The communication between the host computer is error	<ol style="list-style-type: none"> 1. The address and baud rate are incorrectly set. 2. The communication cable is loose. 	<ol style="list-style-type: none"> 1. Check the communication address and baud rate Settings (please change the baud rate to 2400). 2. Check whether the communication cable is loose. 3. Contact installation partner.
DSP communication error		
Grid Short Circuit	The AC input is short circuit.	<ol style="list-style-type: none"> 1. Check whether the AC input cable of the inverter is short-circuited. 2. If the error message persists, contact installation partner.
Load short circuit	Output short circuit.	<ol style="list-style-type: none"> 1. Remove load. 2. Restart system.
IsoFault	The PV panel is installed abnormally	<ol style="list-style-type: none"> 1. Check whether the PV panel is installed correctly 2. Check the PV insulation resistance to the ground;

8.2 Maintenance

	Danger!
	<p>Please pay attention to the following matters</p> <ul style="list-style-type: none"> • Do not place RX-5006Plus/7006Plus/5010Plus/7010Plus/5013Plus/7013Plus near the fire, there may be explosion risk. • Do not open RX-5006Plus/7006Plus/5010Plus/7010Plus/5013Plus/7013Plus without permission.
	Danger!
	<p>Please read the following items carefully before installation:</p> <p>(A) Remove watches, rings or other metallic objects.</p> <p>(B) Use tools with insulated handles</p> <p>(C) Wear rubber gloves and insulated shoes</p>



The repair of the battery should be carried out or supervised by personnel with battery knowledge and necessary precautions. Do not mix batteries of different types and capacities, please use all batteries of the same model. If the inverter is not used for more than 7 days, turn off the AC input, PV input, and battery input switches.

If it has not been used for more than 3 months, turn on the AC input switch (or PV switch) and battery switch, and start the system to replenish the battery once.

Maintenance of batteries should be carried out or supervised by authorized personnel and necessary protection measures should be taken. Do not mix batteries of different types and capacities. All the battery should be the same model.

If the inverter is not in use for more than seven days, turn off the AC input, PV input, and battery input switches.

If it has not been used for more than 3 months, turn on the AC input switch (or PV switch) and the battery switch to start the system to recharge the battery once.

8.3 Routine Maintenance

Item	Method	Period
System Clean	Check the temperature and dust of the Storage Unit. Clean the unit enclosure if necessary.	Six Months to a year
Cable Entry	Check whether the cable entry is insufficiently sealed or the gap is excessively large; and reseal the entry when necessary.	Once a year
Electrical Connection	Check whether all cables are firmly in place. Check whether a cable is damaged (rodents. Physical damage, weather etc).	Once a year

9 Redx Power App

The Redx Power APP can establish communication connection to the energy storage unit via WIFI and or 4G (optional) network. Users can use the APP to view basic information, alarms, and events, set parameters, or download logs etc.

Note: Install the APP or open web page according to the attached instructions, and then configure the WIFI connection.

10 Quality Assurance

When a product faults during the warranty period. REDX will provide a new product.

Evidence

During the warranty period, the customer shall provide the product purchase invoice and date. Since the date of purchase by the user from Redx (hereinafter referred to as the manufacturer), the user will enjoy the following after-sales warranty service

- 1.A 10-year warranty commences from the date of shipment from, during the warranty period the company provides free repair or replacement of new products.
- 2.Any paid service (extended warranty) is available from the date of shipment from manufacturer.
- 3.Disclaimer: Product faults caused by the following reasons are not within the scope of the manufacturer's 10 years warranty commitment:
 - (a) The user does not perform the correct operation according to the procedures listed in the product specification.
 - (b) Repairing the product without communicating with the manufacturer or changes the product without permission, resulting in product failure.
 - (c) Users not following the standards.
 - (d) The fault of the module caused by unsuitable environment.
 - (e) Due to earthquake, fire, natural disasters, lightning strike, abnormal voltage raise, ionizing radiation or other natural disasters caused by external factors.

4. Under the following circumstances, the manufacturer has the right not to provide warranty service.

- (a) Brand, trademark, serial number, nameplate and other marks marked by the manufacturer in the product are damaged or cannot be identified.
- (b) The customer fails to pay off the products according to the Purchase and Sales Contract signed by both parties.
- (c) The user intentionally conceals the improper use of the product during installation, wiring, operation, maintenance or other processes to the after-sales service provider of the manufacturer.

*Redx reserve the right to change the contents of this specification and product performance without informing users.

11 Appendix

11.1 Optional Accessories

The following table lists the optional accessories of the system, contact the manufacturer or distributor for further information

Name	Notes / Purpose
Data Collector	Data Collector (Wi-Fi)
Data Collector	Data Collector (4G)
Smart Meter	Single phase smart meter

Note: The anti-reflux function requires a smarter meter .

12 Contact

If you have any questions about our products, please contact our service hotline or dealers. please provide the following information when inquiring:

- 1.System serial number
- 2.System model
- 3.Fault code/Name
- 4.Briefly describe the fault symptom



For more information, please scan QR code or visit
www.redx.com.au



Download the Redx App with the above QR Code

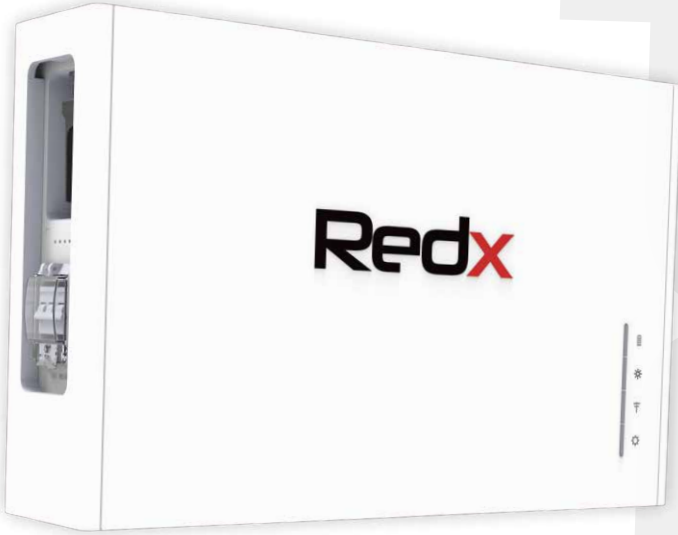

Redx



Address: 28 Warehouse Cct, Yatala, QLD, 4207 Website:
www.redx.com.au

Email: sales@redx.com.au

Tel: +61 7 5672 9983

Specifications are subject to changes without advance notice.