

Redx

Redx

User Manual

RX SERIES INVERTER

RX-5000AC

Redx



All Rights Reserved

No part of this document can be reproduced in any form or by any means without the prior written permission of Redx.

Trademarks

Redx and other Redx trademarks used in this manual are owned by Redx.

All other trademarks or registered trademarks mentioned in this document are owned by their respective owners.

Software Licenses

It is prohibited to use data confirmed in firmware or software developed by Redx, in part or in full, for commercial purposes by any means.

It is prohibited to perform reverse engineering, cracking, or any other operations that compromise the original program design of the software developed by Redx.

Contact Us

Redx Technology Australia Pty Ltd

Address: U2 /21 Millennium Circuit, Helensvale, Australia 4212

Tel: +61 7 5672 9983

Email: info@redx.com.au

Website: www.redx.com.au

ABN: 76614340546

About This Manual

This manual mainly describes the product information, installation, operation, and maintenance guidelines of the Redx inverter (RX-5000AC). Please read this manual carefully before using this product and store the manual in a safe place. Redx will not notify the user of any changes to this manual.

This manual applies to the RX-5000AC inverter. The inverter must be installed by a qualified/licensed technician electrical. We strongly recommend that installers read this manual carefully. The manual includes the guidance on product installation, troubleshooting, communication and other aspects

Contents

1 Safety	1
1.1 Important Safety Instructions.....	4
2 Product Introduction	4
2.1 System Diagram.....	4
2.2 Product Details.....	7
2.3 Led Indicator Panel and Switches.....	10
2.4 Technical Data	12
2.5 Product Features.....	14
3 Installation	17
3.1 Installation Preparation.....	17
3.2 Installation Tools.....	18
4 Installation Guide	19
4.1 Mounting Guide.....	19
5 Electrical Connection	20
5.1 Battery Connection.....	20
5.2 Port Instruction.....	21
5.3 Earth Connection.....	21
5.4 Battery Power Cable Wiring.....	22
5.5 WiFi/4G Dongle.....	22
5.6 Communication Connection.....	23
5.7 Grid Connection.....	25
5.8 EPS Load Connection.....	27
6 Operation	28
6.1 Checklist Before Operation.....	28
6.2 Operation Checks.....	30
6.3 Operation Modes.....	30
6.4 Communication.....	32
7 RX-5000AC System Turn On and Turn Off	32
7.1 Turn on/off RX-5000AC.....	32
8 Troubleshooting & Maintenance	32
8.1 Troubleshooting.....	32
8.2 Maintenance.....	35
8.3 Routine Maintenance.....	36
9 Redx Power App	37
10 Quality Assurance	37
11 Appendix	38
11.1 Optional Accessories.....	38
12 Contact	39

1 Safety

1.1 Important Safety Instructions

The RX-5000AC inverter has been designed and tested strictly according to international safety regulations. Read all safety instructions carefully prior to any work and always observe them when working with the inverter.

Incorrect Operation or Work May Cause:

- Injury or death to the operator or third party.
- Damage to the inverter and other property or third party.









Safety Instructions



- (a) Do not open the case as risk of electric shock
- (b) Maintenance should be carried out by a professional licensed technician
- (c) Read this manual before operating the system. Redx is not responsible for failure or loss arising out of improper operation.
- (d) All wiring, installation, commissioning, and other work should be done by a licensed technician
- (e) Ensure that the storage unit is not installed or used in the following locations:
 - Poorly ventilated room
 - Places with inflammable gases or corrosive materials and large amounts of dust
 - High or low Environment temperature (above 50°C or below -20°C), or high humidity (greater than 90%)
 - In direct sunlight or near heating equipment

In case of fire, use dry powder fire extinguishers instead of liquid fire extinguishers.

All electrical connections are subject to the local grid safety regulations and the storage system should be reconnected to the grid under conditions of approval.

Table 1-1 - Warnings

	<p style="text-align: center;">Danger!</p> <p>Removal of any protection, incorrect use, incorrect installation, or incorrect operation may result in death/serious personal injury or device damage. Transportation, loading and unloading, installation, start-up and maintenance must be carried out by qualified or trained engineer/technician.</p>
 	<p style="text-align: center;">Danger!</p> <p>Before maintenance or touching any parts, or installation, make sure that the energy storage unit is disconnected and wait 5 minutes to ensure that the internal capacitor is discharged.</p>
	<p style="text-align: center;">Warning!</p> <p>Installation must be in full compliance with national and local laws and regulations.</p>
	<p style="text-align: center;">Warning!</p> <p>Ensure that the system is positioned correctly and is not allowed to roll sideways or upside down.</p>
	<p style="text-align: center;">Warning!</p> <p>Do not change the internal circuit of the machine without permission.</p>
	<p style="text-align: center;">Warning!</p> <p>Before connecting to the grid, system the must be connected to the Ground. Follow the instructions. Improper operation may cause serious damage.</p>
	<p style="text-align: center;">Notice!</p> <p>There is a 4G/WIFI device connecting to the inverter, do not place the system in an environment where there is no 4G/WIFI signal.</p>

	Warning!
	<p>The product is not tested to section 5 of AS/NZS 4777.2:2020 and is not to be used in multiple inverter combinations without additional considerations by the system designer</p>
	Warning!
	<p>The load capacity of the output of the inverter load is as follows: Inductive load (such as air conditioning, washing machine, motor, etc.). Single maximum power 3.5kVA, total inductive load maximum power 4.2kVA (with power grid); Capacitive load (e.g. computer, switching power supply, etc.). The maximum power of the total capacitive load is 3.5kVA (without power grid); The maximum power of the total capacitive load is 4.2KVA (with power grid).</p>

2 Product Introduction

2.1 System Diagram

RX-5000AC is an AC-coupled inverter. AC-coupled inverter provides advanced storage and upgrading solutions to the PV grid-connected inverters(any brand or model), enabling the existing system to benefit from energy storage capability and emergency power supply. The AC-coupled inverter will detect the energy generated by the grid-connected inverter, which will be used by the local load first, and the rest will be stored in the battery through the AC-coupled inverter, and the surplus energy will be fed back to the grid.

Anti-Islanding Protection

The Islanding effect is a special phenomenon when a grid-connected PV system supplies power to the grid, when the grid has suffered a power loss. Feeding power into a grid during a power loss is dangerous for maintenance personnel and the public. The RX-5000AC inverter provides Anti-Islanding Protection to prevent the islanding effect.

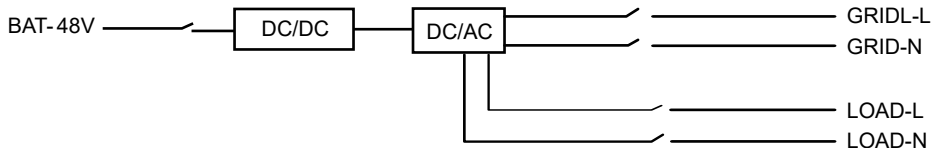

Figure 2.1.1 - The internal system diagram

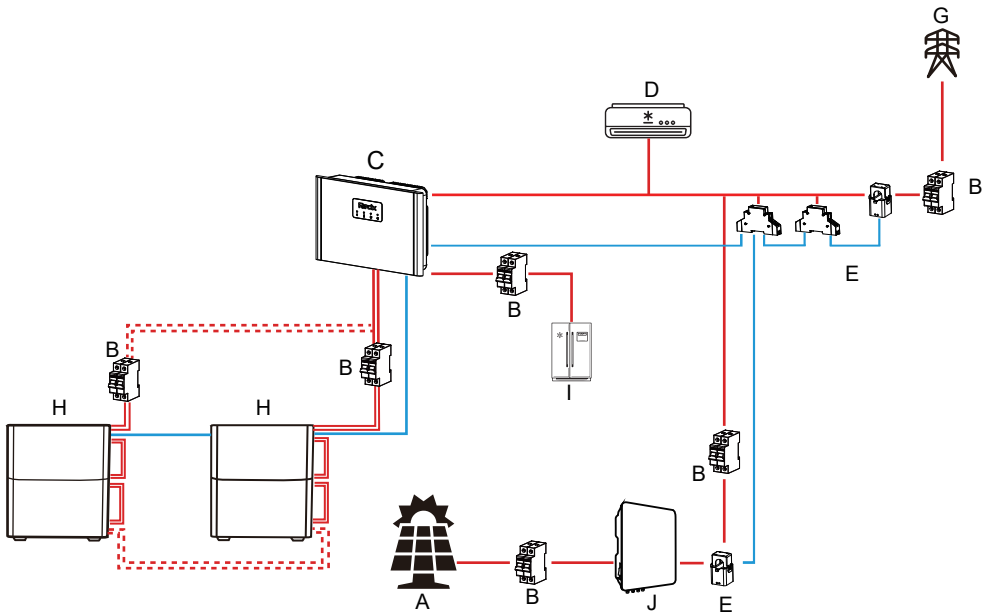

Figure 2.1.2 shows the typical application of the RX-5000AC inverter.

—Red indicates a power cable, —Blue indicates a signal cable

The explanation is as follows:

Table 2.1.2 - Diagram elements explained

Number	Name
A	PV Panel
B	Circuit Breaker
C	RX-5000AC Inverter
D	Regular Loads
E	Smartmeter/CT
G	Grid
H	Low Voltage Battery
I	Backup Loads
J	Third Party Inverter

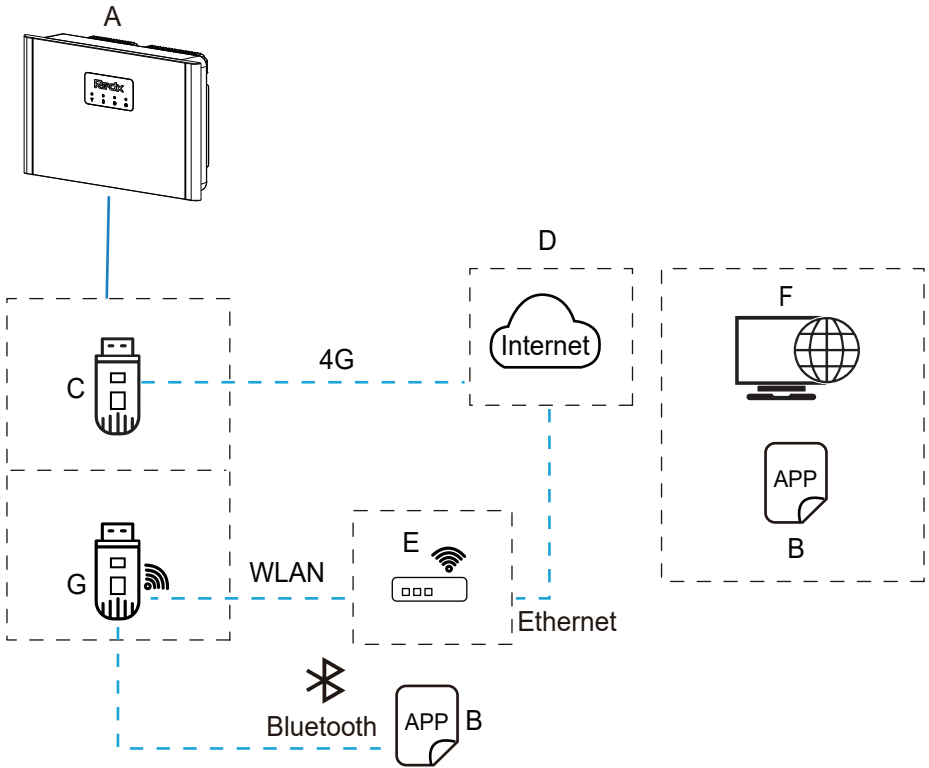

Figure 2.1.3 The communication components (dashed boxes indicate optional components) of the RX-5000AC inverter.

— Blue indicates a signal cable, - - · Blue hidden indicates wireless communication

The explanation is as follows:

Table 2.1.3 - Diagram elements explained

Number	Name
A	RX-5000AC
B	Redx Power App
C	4G Module
D	Internet
E	Wi-Fi Router
F	Cloud Server
G	Wi-Fi Module

2.2 Product Details

2.2.1 Appearance and Dimensions

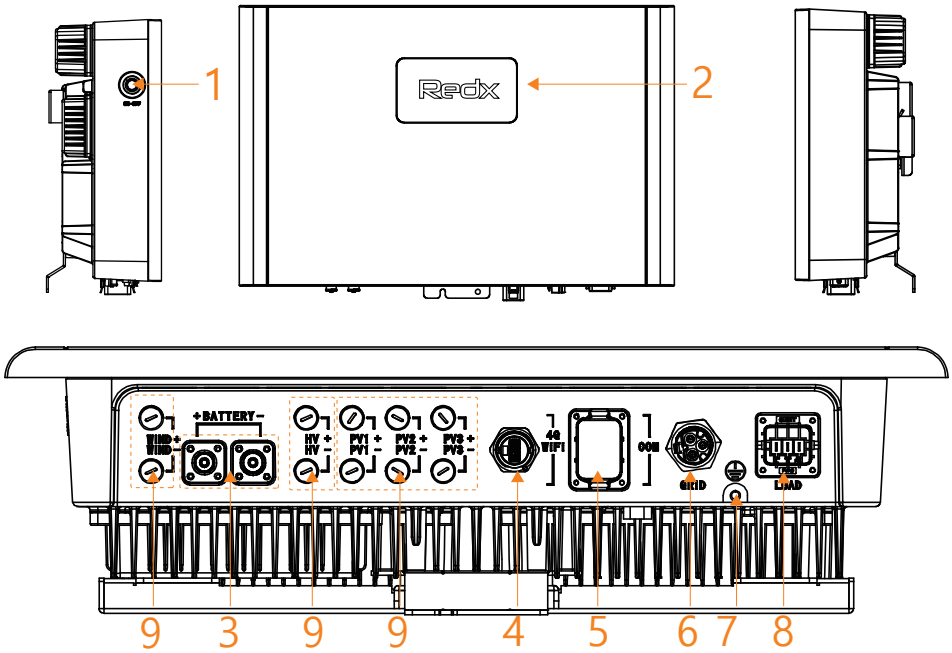

Figure 2.2.1 RX-5000AC terminals

Table 2.2.1 - Diagram elements explained

Items	Name
1	On/off Switch
2	LED interface
3	BAT
4	WIFI / 4G
5	Communication connector
6	Grid connector
7	Protective grounding / Earth link
8	EPS LOAD connector
9	N.C.

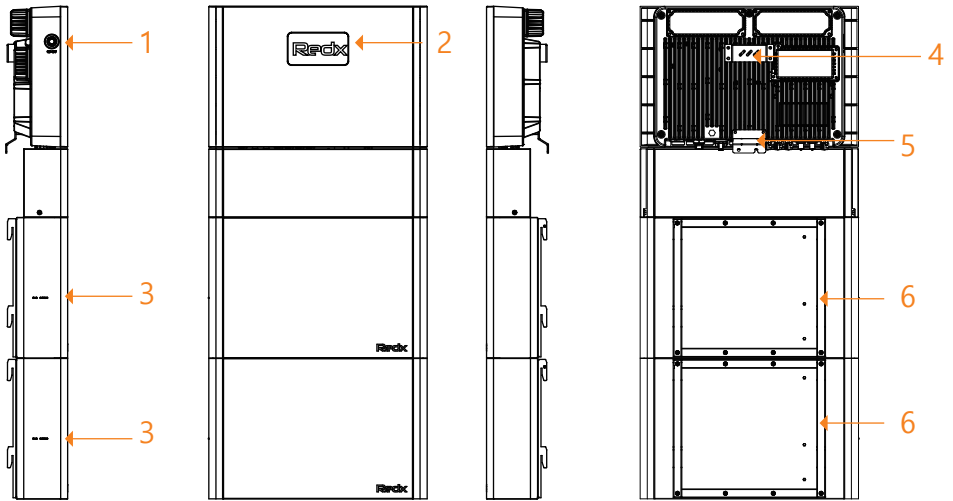

Figure 2.2.2 RX-5010AC Assembly diagram

Table 2.2.2 - Diagram elements explained

Items	Name
1	Main Power Switch
2	LED Interface
3	SOC Indicator
4	Inverter Bracket
5	Inverter Bracket 2
6	Battery Bracket

Note: The inverter is only compatible with Redx Batteries. 2-8 (10-40kWh) Redx RX-0050 (lithium iron phosphate) batteries must be installed to the inverter.

2.2.2 Dimensions

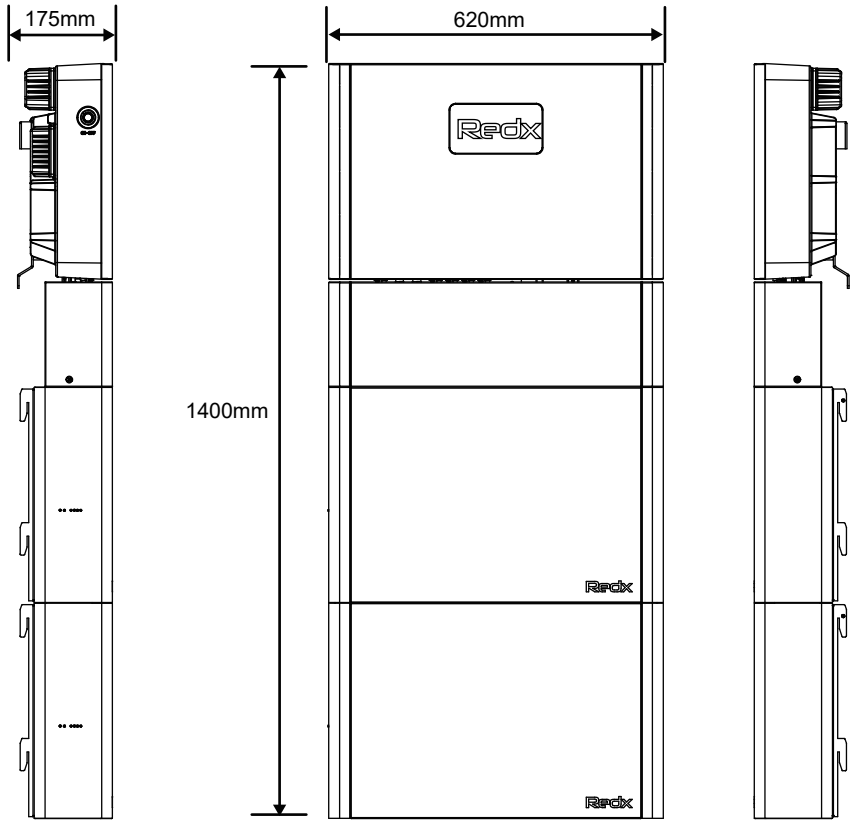
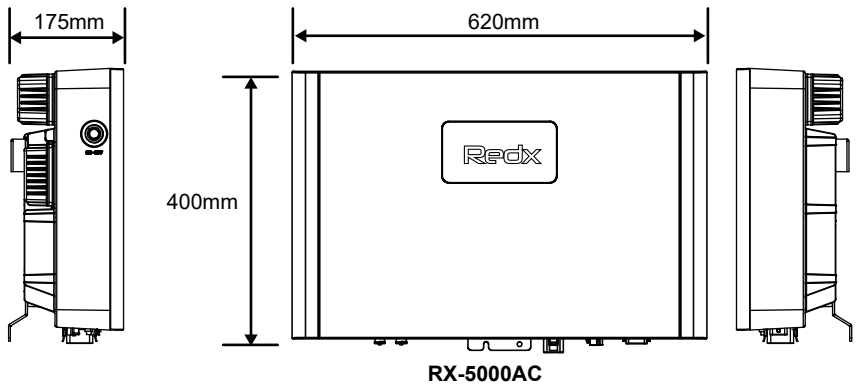

Figure 2.2.3 RX-5000AC Dimensions

2.3 LED Indicator Panel and Switches

Main power switch







 ON - OFF		ON
		OFF

Figure 2.3.1- RX-5000AC On-Off switch

Table 2.3.1 - Status LED elements explained

LED indicator

	System indicator	Green flash	Startup conditions are not met
		Green	Normal
		Yellow	System warning
		Red	System fault
	PV indicator	None	No PV
		Green	Normal
		Yellow	PV undervoltage
		Red	PV fault
	Battery indicator	None	No battery
		Green flash	Charging
		Green Solid	Discharging
		Yellow	Battery warning
		Red	Battery fault
	Grid indicator	None	Grid disconnected
		Green Flash	Power imported from grid
		Green Solid	Power exported to grid
		Yellow	Grid warning
		Red	Grid fault

Communication Interface Pin Definition

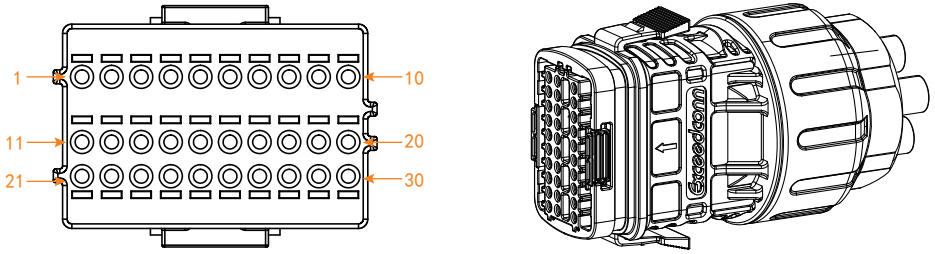

Figure 2.3.2 - RX-5000AC Communication interface

Table 2.3.2 - Diagram elements explained

Pin	Group	Definition	Pin	group	Pin
1	A1	Dry contact 1 Public	16	B8	DRM0-
2	A2	Dry contact 1 open	17	B7	DRM0+
3	A3	Dry contact 1 close	18	B6	GND
4	A4	Dry contact 2 Public	19	B5	485C-
5	A5	Dry contact 2 open	20	B4	485C+
6	A6	Dry contact 2 close	21	D1	Switch input negative
7	/	/	22	D2	Switch input positive
8	B1	485D+	23	D3	CT+
9	B2	485D-	24	D4	CT-
10	B3	GND	25	D5	reserved
11	C1	BMS_CAML	26	D6	reserved
12	C2	BMS_CANH	27	D7	reserved
13	C3	GND	28	D8	reserved
14	C4	BMS_485A+	29	D8	reserved
15	C5	BMS_485A-	30	D10	reserved

2.4 Technical Data

GENERAL	
Internal on/off grid switch	Yes
Operating temperature range	-10°C to 50°C
Display/indicators	LED indicators
Cooling	Convection
Size W*H*T	620mm X 400mm X 162mm
Weight	22.5KG
IP rating	IP65
Protective Class	Class I
Altitude	<2000 m
Over Voltage Category	AC:OVC III DC:OVC II Others: OVC I
The decisive voltage class	DC,AC:DVC C, other ports: DVC A
Active anti-islanding method	Reactive disturbance
Inverter Topology	Isolated
GRID	
Rated Output Power	5kW
Voltage range	175~280Vac
Rated line frequency	50Hz/60Hz ±10%
Rated Output current	22Aac
Max AC current	25A
Total THD	<5%
Load regulation	<3%
Output power factor	0.8 leading - 0.8 lagging
Inrush current	26A
Max output fault current	80A
Max output overcurrent protection	25A
LOAD OUTPUT	
Output power (with battery only)	5kW
Rated output voltage (off grid)	230V (220/230/240 settable)
Frequency (off grid)	50Hz/60Hz ±0.01Hz
Rated output current	22Aac
Max AC current	25A
Max efficiency (battery to AC output)	96.00%

BAT LV	
Rated Power	5kW
Rated voltage range	42~58Vdc
Max Charge/Discharge Current	115A _{dc}
PROTECTION FUNCTIONS	
Islanding protection	YES
Anti-backflow	YES
DC reverse connection protection	YES
AC output short circuit protection	YES
DC fuse (battery side)	YES
Overcurrent protection	YES
Over-temperature protection	YES
COMMUNICATION	
RS485_A&CAN	BMS
RS485_B	WIFI/4G/BLUETOOTH
RS485_C	Meter/Turbine/EV
RS485_D	Parallel/Reserved
CT	External CT
Dry_contact_1	External DPDT switch
Dry_contact_2	Generator
Digital input	Turn on/Turn off (5V,0.1A)
DRM0	DRM0
STANDARDS	
Safety standard	IEC 62109-1; IEC 62109-2;IEC62040
EMC standard	EN 61000-6-1, EN 61000-6-2, EN61000-6-3,EN61000-6-4,
Grid connection standard	AS4777.2

2.5 Product Features

- a. Backup power supply
- b. Compatible with various application scenarios
- c. Intelligent management
- d. Remote scheduling
- e. Multiple protection

3 Installation

Storage

Store the storage unit properly when the unit is not installed immediately

- Store the unit in the original packaging box
- Storage temperature should be always between 0°C and 50°C+
- The packaging box should be upright.

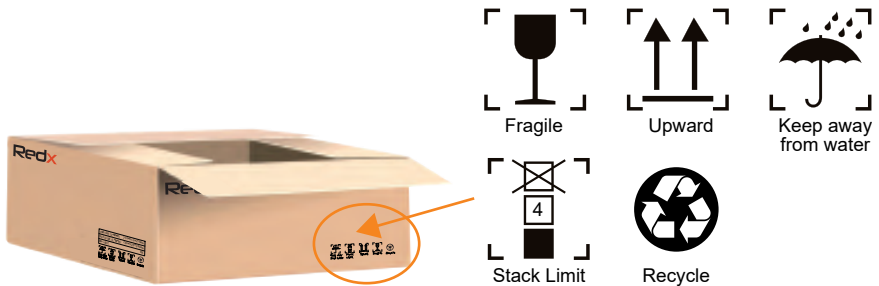

Figure 3.0.1- RX-5000AC packaging

Scope of Delivery

Please check the condition of the packing before unpacking. If any parts are damaged or missing, contact your local supplier for help.

The battery power cables and battery communication cables are included in the inverter box. The communications connector will be pre-assembled to connect the inverter to smartmeters and batteries.

RX-5000AC Standard Accessories

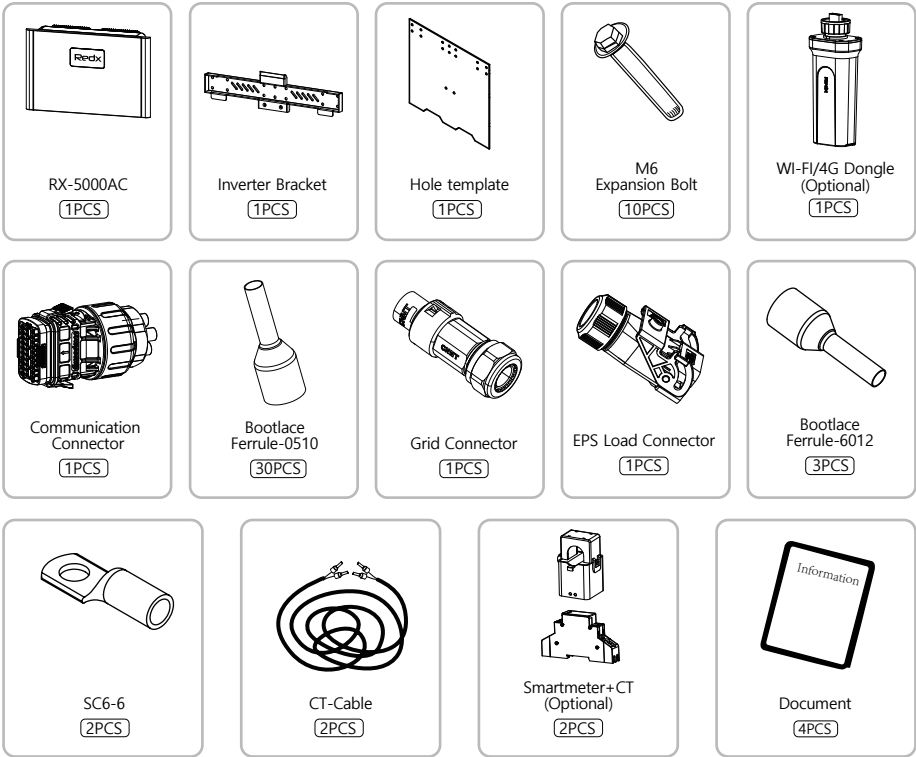

Cover&Connection Parts

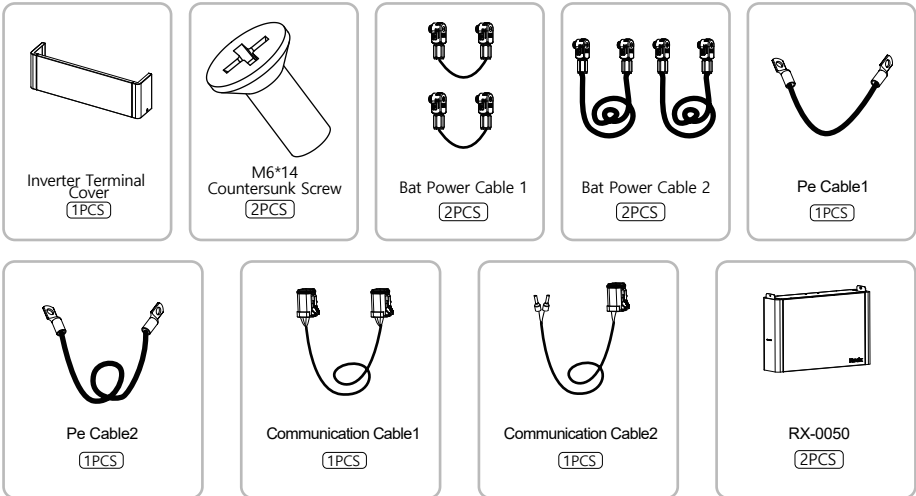

Figure 3.0.2 - RX-5000AC components

RX-5000AC Base components

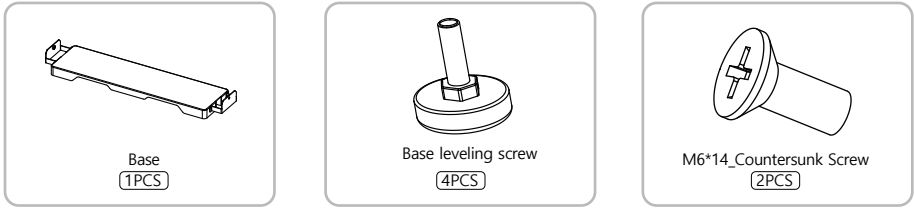
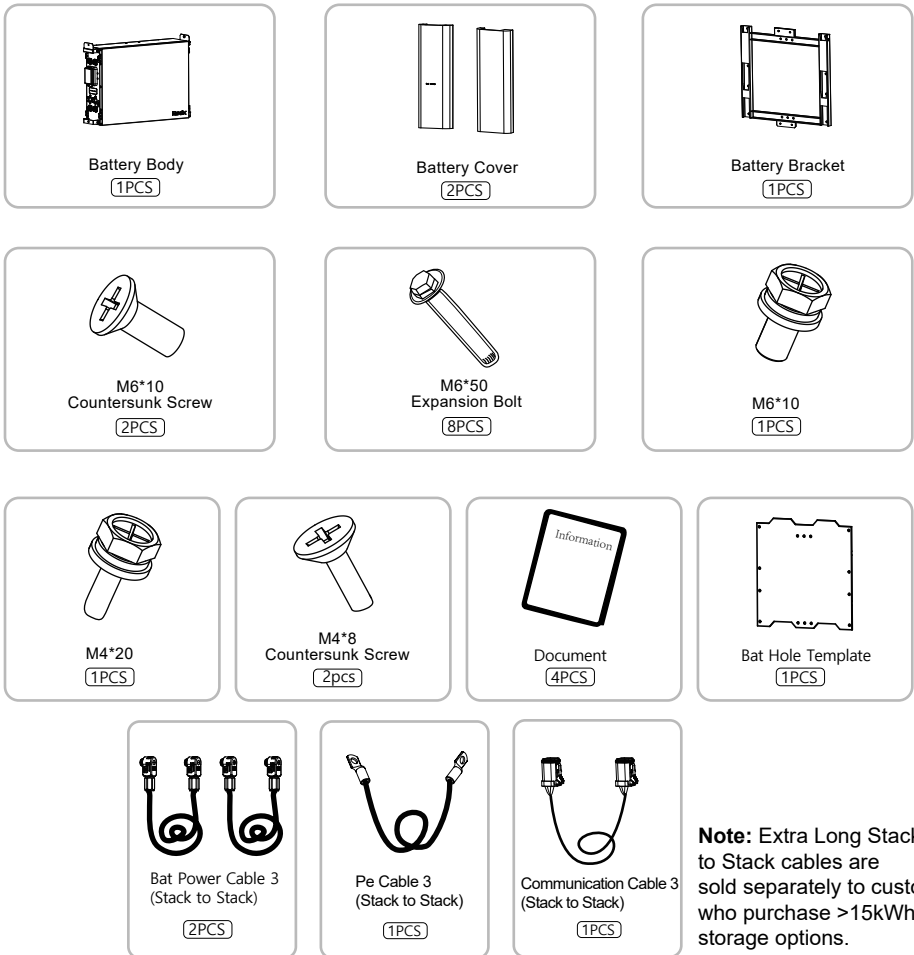

Figure 3.0.3 - RX-5000AC base components

RX-0050 Accessories



Note: Extra Long Stack to Stack cables are sold separately to customers who purchase >15kWh storage options.

Figure 3.0.4- RX-5000AC Accessories

3.1 Installation Preparation

- a. Not to be installed in direct sunlight. Product is designed for indoors. Vertical mounting only.
- b. Install in a ventilated location. There must be enough clearance to ensure that the module operates in the optimal heat dissipation state.
- c. Install at suitable distance from any restricted areas, please review Standard AS/NZS 5139.
- d. Install on a sturdy supported surface.
- e. The location must fit the weight and size of the module.
- f. The environmental temperature must be between -20°C to $+50^{\circ}\text{C}$, and the relative humidity between 0% and 90% (without condensation)
- g. Location shall be dry with adequate air flow (Pollution Degree < PD3) .
- h. Installation is prohibited in any of the following environments

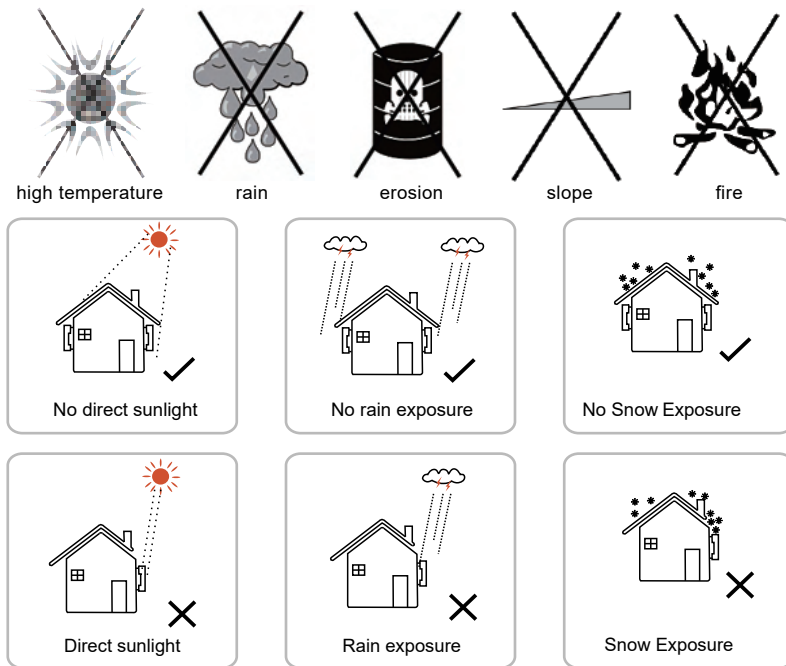



























Figure 3.1.1 - RX-5000AC Installation locations

- a. The minimum clearance on the sides must be maintained at least 300mm.
- b. Installation location of the inverter should be easy for operator to turn off at any time.
- c. Do not install the inverter near signal transmitters / antennas.
- d. Do not install the inverter in the living area.
- e. Do not install the inverter at location where children can easily access.

3.2 Installation Tools

Prepare the following tools before installation:

Figure 3.2.1 - RX-5000AC Installation tools

Type	Tool			
General tools	 Packaging tape	 Marker	 Measuring tape	 Level
	 Utility knife	 Multimeter Measurement range: $\geq 1100\text{Vdc}$	 Protective clothing	 Wrist strap
	 Protective gloves	 Dust mask	 Ear protection	 Eye protection
	 Insulated shoes	 Vacuum cleaner		
Installation tools	 Hammer drill with ø8mm bit	 Rubber mallet	 Slotted screwdriver	 Phillips screwdriver Specification: M4, M6
	 Wire stripper	 Hydraulic crimper	 Crimping pliers	 Combination pliers
	 RJ45 crimping pliers	 Hammer drill	 Bootlace ferrule crimper	

4 Installation Guide

4.1 Mounting guide

Avoid water and electricity when drilling, bit size $\varnothing 8\text{mm}$, drilling depth 40mm.

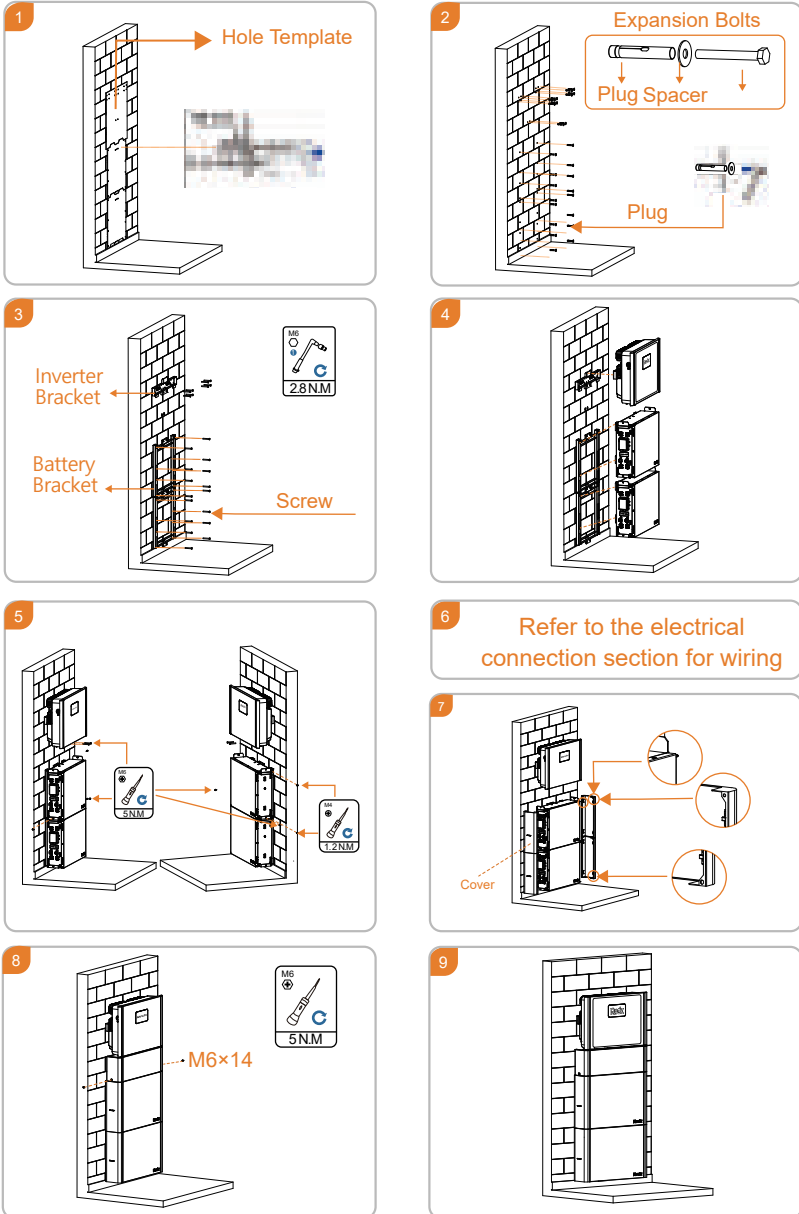

Figure 4.1.1 - RX-5000AC Mounting information

5 Electrical Connection



An independent circuit breaker must be configured for each power interface.

The table below is a recommendation for cable selection and the Recommended specifications of circuit breaker. Engineers should refer to local standards to select cables. Cable length is generally 2 to 10 meters, long cable will lead to voltage deviation from the rated value, consequently requiring an increase of the cross-sectional area.

Table 5.0.1 - RX-5000AC Cabling guide

Power interface	Circuit breaker Suggestion	Cross-sectional area (mm ²)
LOAD	>25A	≥4 mm ²
GRID	>35A	≥6 mm ²

Note: for details about the electrical connection, see Figure 2-1.2.3

5.1 Battery Connection

Battery Connection

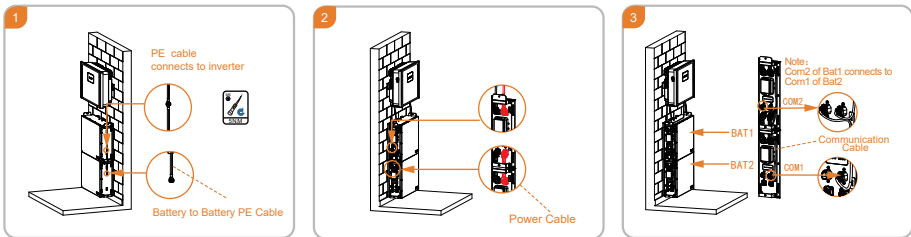

Note: Com1 of Bat1 connects to inverter communications port.

Figure 5.1.1 - RX-5000AC Multiple battery interconnection

5.2 Port Instruction

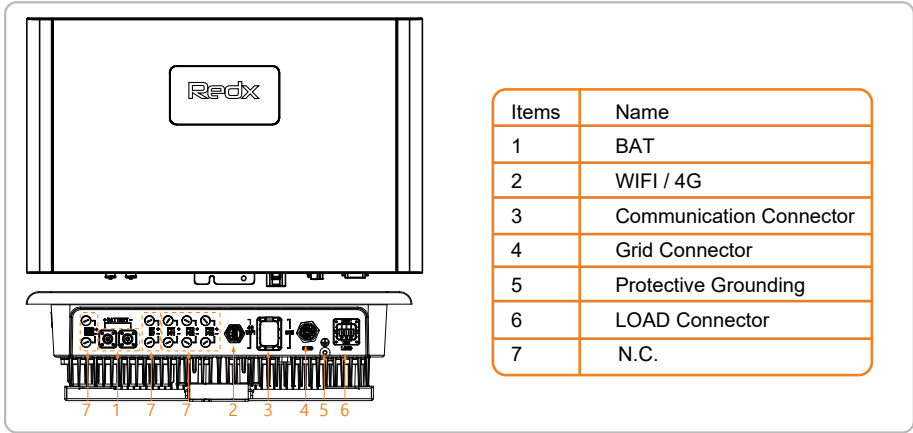

Figure 5.2.1 - RX-5000AC Port Instruction

5.3 Earth Connection

A secondary protection grounding terminal is added for the system. Ensure that the grounding resistance is less than 10Ω and the grounding cable diameter is greater than 6 mm^2 .

PE Wiring

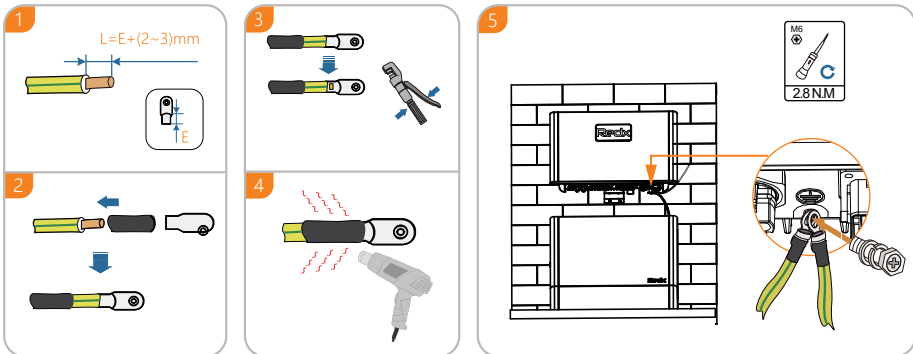
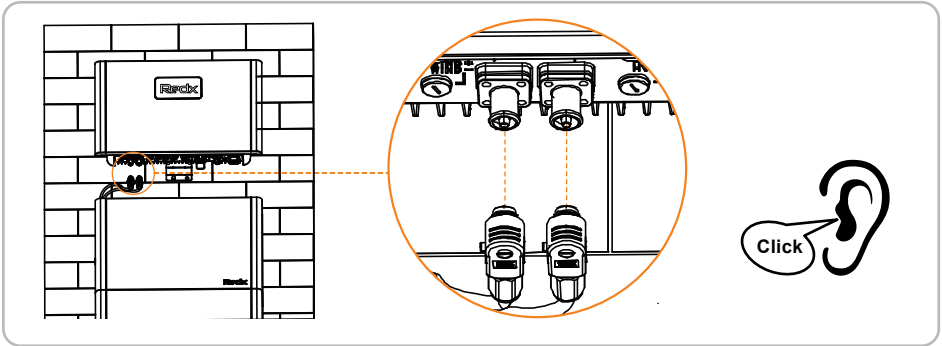

Figure 5.3.1 - RX-5000AC Earthing connection

5.4 Battery Power Cable Wiring



Note: you will hear a 'Click' sound if the battery connector is connected correctly.
When removing a battery cable, press the button on the cable terminal.



5.5 WiFi/4G Dongle

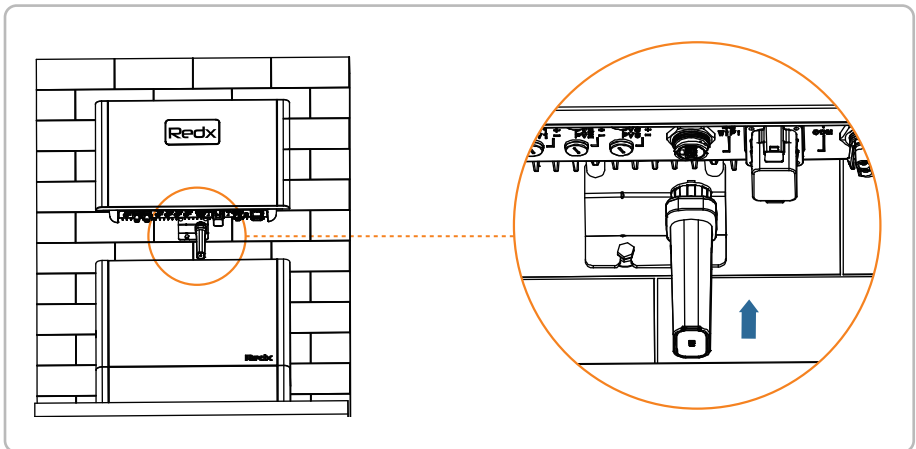

5.6 Communication Connection

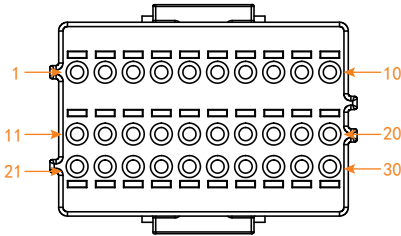

Pin	Group	Definition	Pin	Group	Pin
1	A1	Dry contact 1 Public	16	B8	DRM0-
2	A2	Dry contact 1 open	17	B7	DRM0+
3	A3	Dry contact 1 close	18	B6	GND
4	A4	Dry contact 2 public	19	B5	485C-
5	A5	Dry contact 2 open	20	B4	485C+
6	A6	Dry contact 2 close	21	D1	Negative Input For Switch
7	/	/	22	D2	Positive Input For Switch
8	B1	485D+	23	D3	CT+
9	B2	485D-	24	D4	CT-
10	B3	GND	25	D5	Reserved
11	C1	BMS_CAML	26	D6	Reserved
12	C2	BMS_CANH	27	D7	Reserved
13	C3	GND	28	D8	Reserved
14	C4	BMS_485A+	29	D9	Reserved
15	C5	BMS_485A-	30	D10	Reserved

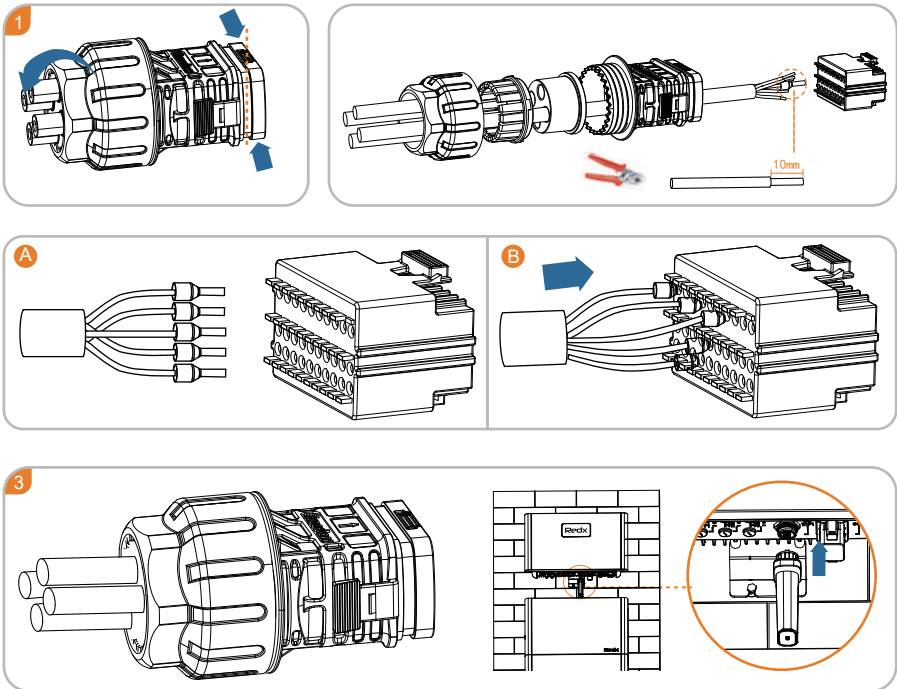

Figure 5.7.2 - RX-5000AC Communication connector

5.6.1 Connect Battery 2 to Pin11 and Pin12 in the COM terminal of the inverter using the"Communication cable 2pin"

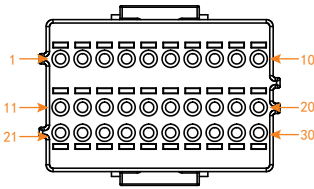
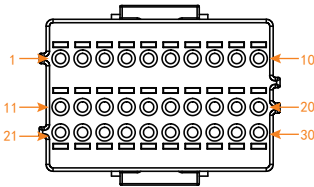

Table 5.6.1 - RX-5000AC Communication connector

Pin	Group	Definition
11	C1	BMS_CAML
12	C2	BMS_CANH

5.6.2 CT/METER Connection

The CT/METER is used to monitor the status of the energy consumption.



Pin	Group	Pin
23	D3	CT+
24	D4	CT-

Figure 5.6.2 - RX-5000AC Communication connector CT pins

CT cable specifications: if the cable is not long enough, adding an extension cable (max 10m), contact the local supplier in advance.

The direction of CT installation as shown in Figure 5-6.2. The arrow direction on the CT must point to the power grid.

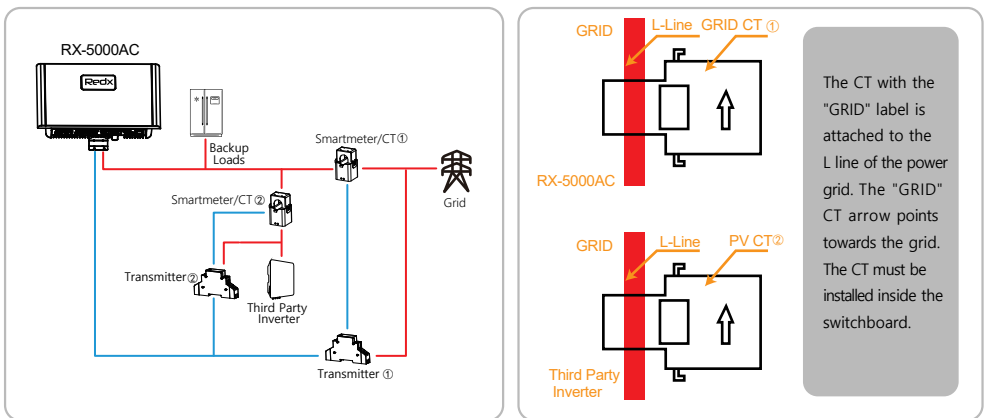

Figure 5-6.2.1 CT and smartmeter diagram

As shown in figure 5-6.2.1 an arrow indicates the direction of the CT, pass cable through the hole of the CT then lock the CT.

The RS-485 communication connection is shown as follows:

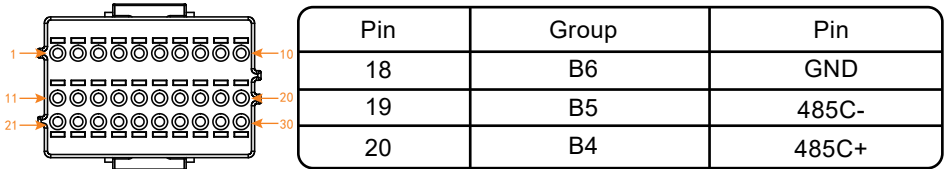

Figure 5.6.2.2 - RX-5000AC Communication connector 485 pins

5.6.3 Connection of DRM0 Terminal (Australia Only)

When RX-5000AC is installed in some states in Australia, the DRMS terminal needs to be connected. The connection method is as follows:

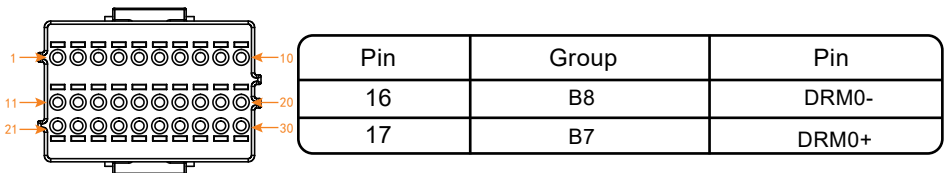

Figure 5.7.3 - RX-5000AC Communication connector DRM pins

5.7 Grid Connection

Requirements

1. Install an AC circuit breaker between the inverter and the grid, before connecting the system to the grid.
2. Grid voltage and grid frequency should be within the allowable range of inverter operation.

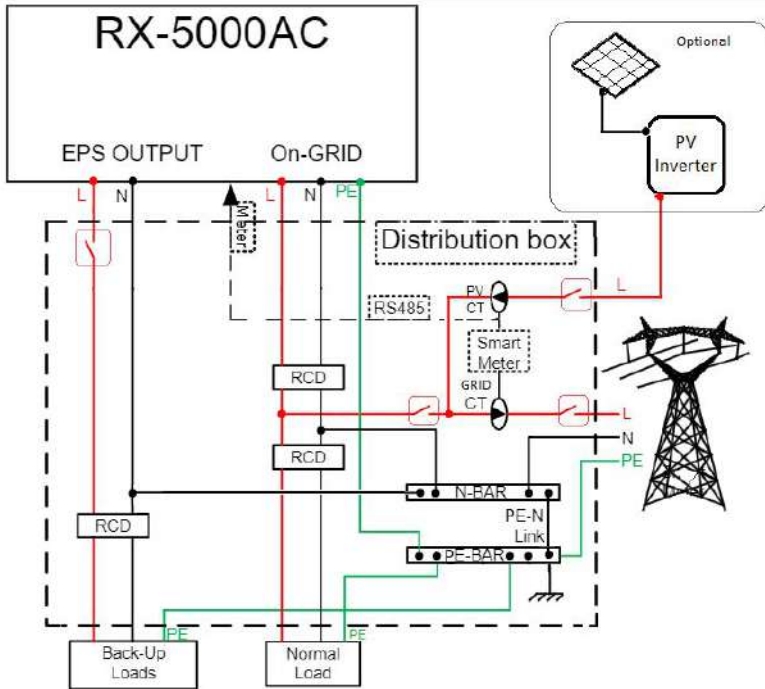

Figure 5.7.1 - RX-5000AC 240V electrical connection with EPS

Note:

The battery inverter does not have an internal RCD as it is isolated. If an external RCD breaker is mandatory in the country of installation, it must be a type A RCD with the rating residual current not more than 30mA.

1. If you need to use both the grid and backup power functions, refer to Figure 5.7.1 for connection details.
2. The grid terminal and EPS terminal cannot be directly connected together, otherwise the system will be damaged.
3. The inverter can work in off-grid without grid input, in this situation the EPS Load port is supplying power to the Back Up Loads only. The grid-tied PV inverter will not produce power whilst off-grid.

Steps

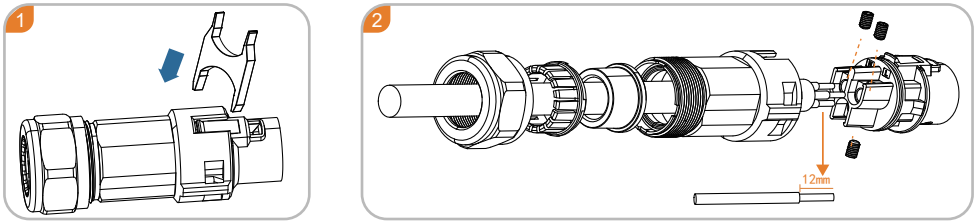

Figure 5.7.2 - RX-5000AC Grid connector

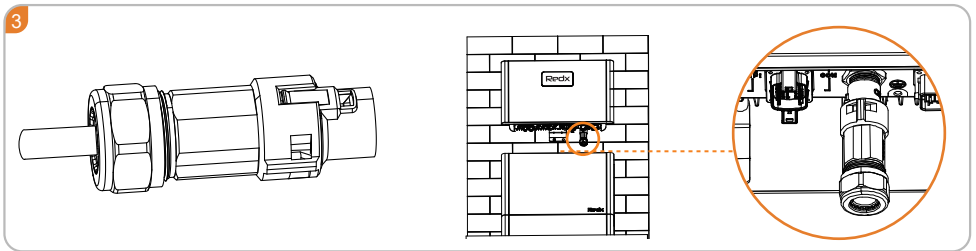
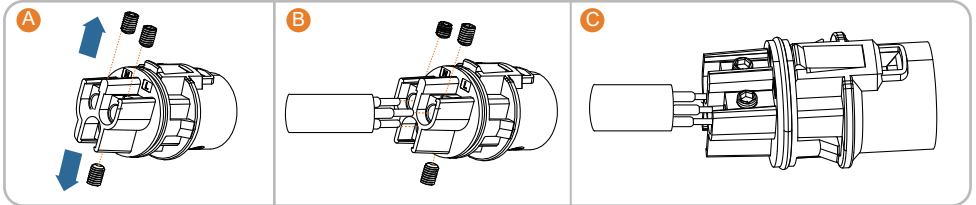

Figure 5.7.3 - RX-5000AC Grid connector assembly



Note: for details about the electrical connection, see Figure 2-1.b,c,d.

- 1.The GRID terminal and off-grid (EPS LOAD terminal cannot be connected together, otherwise the system will be damaged.
- 2.The battery needs to be activated by the grid when the system starts for the first time.

5.8 EPS Load Connection

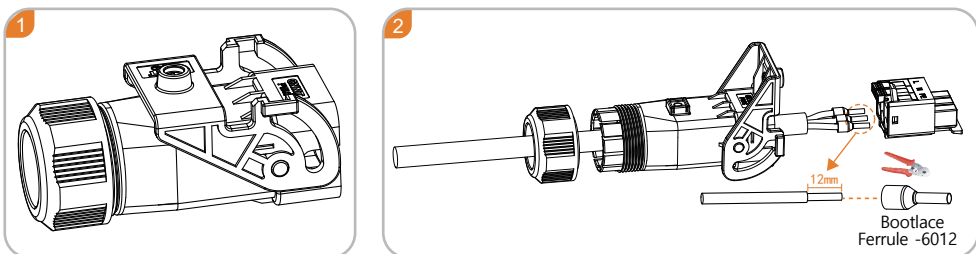

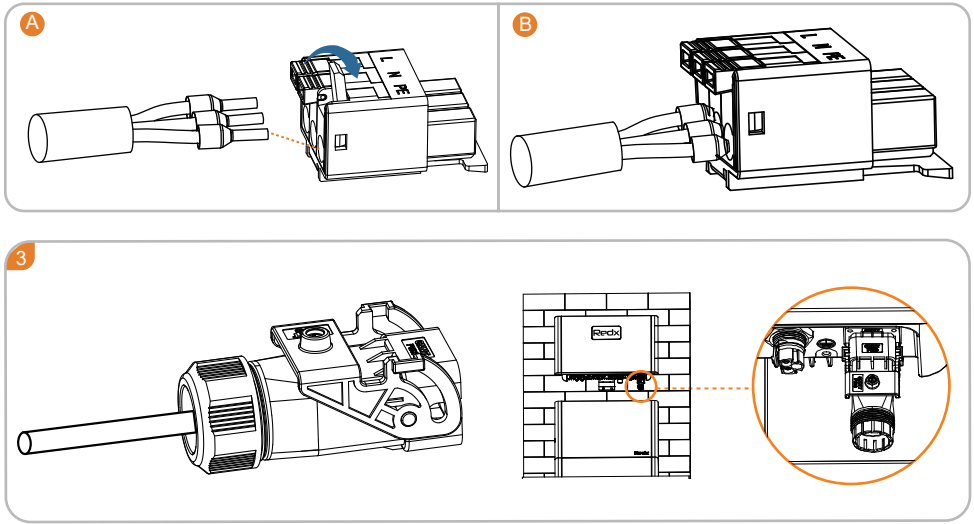

Figure 5.8.1 - RX-5000AC EPS connector assembly



Do not connect the port to other power supplies. Otherwise, the inverter may be damaged, causing risks.

6 Operation

6.1 Checklist Before Operation

1. Check whether the system is firmly installed, and the installation position is easy for operation and maintenance.
2. All cables are correctly connected, properly distributed, and well protected, and no mechanical damage is caused.
3. The selection of AC circuit breakers is correct.
4. The wiring terminals are securely installed, and the vacant terminals are sealed.
5. All safety signs and warning labels on the system are firmly and clearly visible

6. The installer must select the correct regional settings for the inverter. The installer will be able to select the correct regional settings in the app during commissioning. Selecting the customer's relevant Grid Operator will automatically allocate and lock the relevant Regional settings, the settings will now be password protected. Alternatively the installer can login to www.redxpower.com with their installer credentials. Then they must navigate to Devices page, find their device by typing in the device serial number in the search field, then click on the device serial number and select the correct region in the Deploy section. The installer can also edit the Generation and Export Limit Control Settings and Power Quality Response Mode settings on the Deploy page which are also password protected. The installer can request the password from Redx.



Figure 6-1 - Export Soft and Hard Limit settings on Deploy page

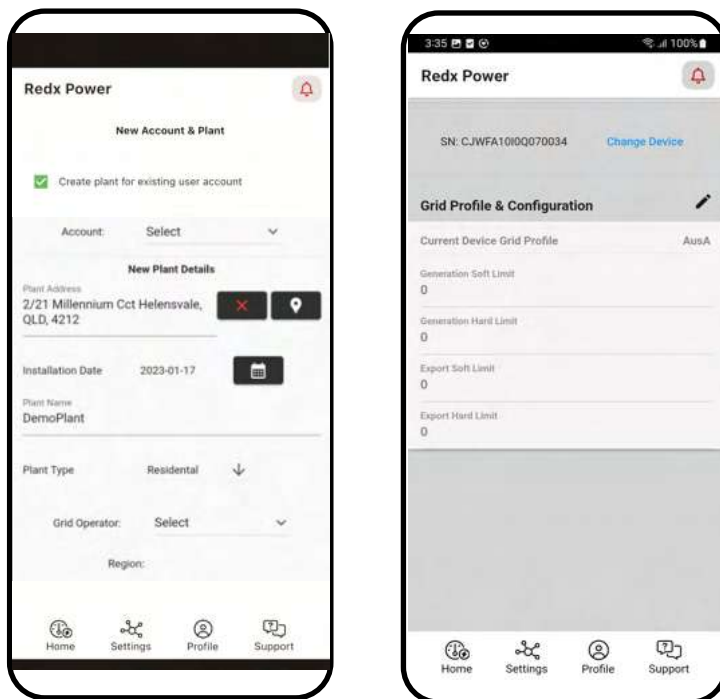

Figure 6-2- Region selector in the Redx Power App

6.2 Operation Checks

1. Confirm that the above checklist meets the guideline.
 2. Turn on all circuit breakers
 3. After the AC circuit breaker is turned on and the LED on the system is on, perform the following operations
 - (a) If the LED indicator does not light up, check if voltage is present on grid input terminals. If there is voltage on the grid terminals, but unit is still not illuminating the LEDs– please contact local Redx dealer.
 - (b) Install the Redx Power APP or open web page according to the attached instructions, and then configure the WIFI connection.
 - (c) Turn on the battery circuit breaker on the side of the system.
 - (d) Press the power button on the side of the system, then the system is in passthrough state and EPS port has output.
 - (e) Set the needed parameters through the web or APP. The battery LED indicator on the panel lights up, and the other LED indicators will light up according to the actual working status.
 - (f) If the operation fails, troubleshooting fault by referring to Chapter 9 in this manual
- Note:** Use grid and the App to activate the battery for the first-time operation.

6.3 Operation Modes

6.3.1 Operating Modes

The 5000AC unit has 3 main modes: Auto, VPP or Timed mode. The default is VPP mode, most units should be configured as Auto mode. The Auto mode includes on-grid and off-grid functionality. By default the Anti - backflow function is enabled. If the anti-backflow function is enabled, then the system will not export power to the grid.

A. On Grid Functionality

1. VPP Mode

The unit works according to the commands sent from the cloud platform. When the cloud platform sends a discharge command, the inverter starts to discharge power from pv/ battery to grid/loads at the set level. When the cloud platform sends a charge command, the inverter starts to charge the battery from grid/pv at the set level.

2. Auto Mode

The unit automatically adjusts the output and charging and discharging status according to smartmeter readings. The energy of the PV will first supply power to the load and use the extra power to charge the battery, any excess will be sent to the grid if Anti-backflow is disabled. If the PV is not enough to cover the load, both the PV and the battery will supply power for the load.

3. Timed Mode

The charging and discharging of the battery can be customized with the set powers within the set times.

B. Off - Grid / EPS Functionality

When the power grid is cut off, the system will automatically switch to off-grid mode. The system will supply power to the EPS loads through the battery. Note: under off-grid mode, the system power output rate only using the battery is 5kW. The load power rate of the EPS end should not exceed 5kW. When the system detects a low battery status, the battery will stop discharging automatically and the battery will be charged when there is solar or other power supply available.

6.3.2 Fault State

The RX-5000AC has a smart control system that continuously monitors and regulates system status. When there is a system fault or equipment fault, fault information will be displayed on the web page /APP, and the LED light will also be on in fault mode.

Notes :

- (A) For details about fault information, see Chapter 8.
- (B) Part of the fault information is used to remind users of possible internal fault of the system

6.3.3 Firmware Update

When the system is upgrading firmware, do not power off. When the upgrade is complete, the system will automatically switch to normal working mode.

6.3.4 Self-check Status

Before entering normal operation mode, RX-5000AC will enter self-check mode. If all checks pass successfully, the system will return to normal working mode; otherwise, the system goes into the fault state.

6.3.5 Standby Status

When the system does not fault but certain operating conditions are not met, the system will turn to standby mode.

6.3.6 Protection Mode

Connecting an oversize load to the EPS terminal will trip the unit and trigger protection mode. The unit will try to restart 3 times, if the load is still present, the unit will revert to protection mode. Remove the oversize load and restart the unit. If any circuit breakers have tripped – contact your installation partner.

6.3.7 Shutdown Status

Disconnect all power supply, turn everything off and the system will automatically enter the Off state. The specific steps are as follows:

1. Turn off the power button
2. Turn off the battery switch
3. Disconnect the grid supply, the LED light and the battery power display LED light will be turned off.

6.4 Communication

The Redx unit has an external data collector, users can choose either WIFI or 4G dataloggers according to their requirements, and use their computer or mobile phone APP (Redx Power) to monitor the inverter and battery status. The default datalogger in the device uses Wi-Fi to connect to the customer's Wi-Fi router to establish an Internet connection. The installer will use Bluetooth to connect to the datalogger and configure the device to connect the datalogger to the local Wi-Fi router during the installation process.

7 RX-5000AC System Turn On and Turn Off

7.1 Turn on RX-5000AC

You can perform the following steps to start the RX-5000AC:

- (1) Turn on the AC and all other relevant circuit breakers.
- (2) Turn on the battery circuit breaker.
- (3) Turn on the power button.
- (4) When the LED display is normal, the system starts normally.

7.2 Turn off RX-5000AC

- (1) Turn off the power button.
- (2) Turn off the battery circuit breaker.
- (3) Turn off the AC and all other relevant circuit breakers.
- (4) When the LED display is off, the system is completely off.
- (5) Wait at least 60 seconds before performing further operations.

8 Troubleshooting & Maintenance

8.1 Troubleshooting



Once a fault occurs in the storage unit, the fault information will be displayed on the APP/web interface.

Fault information	Fault reason	Suggestion
The battery connection error	No battery is detected	If the battery is connected 1. Check whether the battery cable is securely connected and whether the battery voltage is normal. 2. If the error message remains, contact installation partner.
Battery under voltage or over voltage	If the battery voltage is abnormal, the internal circuit protection is triggered	1. Check whether the battery is correctly connected and whether the battery voltage is normal. 2. Make sure the battery is in good condition and restart the module. 3. If the error message remains, contact installation partner.
No grid	No grid is detected	If the grid is connected 1. Check whether the grid terminal is firmly connected and the grid voltage is normal; 2. If the error message remains, contact installation partner.
DC Bus under-voltage	The input is suddenly disconnected	1. When the fault is recovered, the inverter will automatically return to normal working state; 2. If the external environment does not change and the alarm remains after the system is restarted, contact installation partner.
DC Bus over-voltage	The rapid change of power grid voltage may cause high energy input to the inverter. Internal dc-dc converter or charging electronics may have a fault.	1. After the fault error is recovered, the inverter automatically restores to the normal working state. 2. If the fault remains, contact installation partner.
Inverter overvoltage	The output voltage of the inverter is out of the range.	1. Check whether the external load exceeds the specification range of the inverter. After the fault is recovered, the inverter automatically recovers to the normal working state.
Inverter undervoltage		2. If the alarm is repeated, contact installation partner.

Islanding protection	Islanding protection check	<ol style="list-style-type: none"> 1. Check whether the AC circuit breaker of the grid is disconnected and whether the connecting cables are securely connected. 2. Check whether the grid has power. 3. If all conditions are correct and the fault still occurs, contact installation partner.
Grid overvoltage	When the grid detects an error, the inverter automatically switches to the off-grid mode. When the error disappears, the inverter automatically resumes to the grid mode	<ol style="list-style-type: none"> 1. Check the grid voltage or frequency; If the power grid voltage or frequency exceeds the allowable range of converter protection parameters, please report to the power grid company. 2. If the power grid voltage or frequency is within the permissible range, contact the installation partner.
Grid under voltage		
Grid over frequency		
Grid under frequency		
Battery over current	The charge and discharge current of the battery is too high	<ol style="list-style-type: none"> 1. Check whether the battery voltage and capacity exceed the allowable range of the inverter. 2. If the alarm is repeated, contact installation partner.
Relay fault	Detect the fault of relay	<ol style="list-style-type: none"> 1. Wait for the inverter to recover automatically. 2. If the alarm is repeated, contact installation partner.
Bus soft start failed	Bus voltage setup timeout	<ol style="list-style-type: none"> 1. Wait for the inverter to recover automatically. 2. If the alarm is repeated, contact installation partner.
The inverter soft start failed	Inverter output setup timeout	
Inverter phase lock failure	Inverter phase lock fault	<ol style="list-style-type: none"> 1. Wait for the inverter to recover automatically. 2. If the alarm is repeated, contact installation partner.
EEPROM read failure	EEPROM read fault	<ol style="list-style-type: none"> 1. Disconnect power and restart the system; 2. If the error remains, contact installation partner.
Fan fault	The fan is faulty	<ol style="list-style-type: none"> 1. Check whether the fan runs properly. Power off to restart the module; 2. If the error message still exists, contact installation partner.
The grid is connected to the EPS terminals	The AC input and load output cables are incorrectly connected	<ol style="list-style-type: none"> 1. Shut down the inverter and turn off all circuit breakers. 2. Check whether the AC input cable (power grid cable) is connected to the load (EPS) output terminal. If the connection is incorrect, reconnect the cable. 3. If the error message persists, contact installation partner.

Output overload	Overloaded outputs	<ol style="list-style-type: none"> 1. Remove some loads. Ensure that the load is smaller than the maximum output power of the inverter. 2. Restart the inverter.
Radiator over temperature	<ol style="list-style-type: none"> 1. The inverter installation location is not ventilated. 2. The ambient temperature is too high. 3. The fan is faulty. 	<ol style="list-style-type: none"> 1. Check whether the operating environment exceeds the operating temperature range of the inverter. If yes, improve the operating environment. 2. Check whether the fan is in good condition.
The communication between the host computer is error	<ol style="list-style-type: none"> 1. The address and baud rate are incorrectly set. 2. The communication cable is loose. 	<ol style="list-style-type: none"> 1. Check the communication address and baud rate Settings (please change the baud rate to 2400). 2. Check whether the communication cable is loose. 3. Contact installation partner.
DSP communication error		
Grid Short Circuit	The AC input is short circuit.	<ol style="list-style-type: none"> 1. Check whether the AC input cable of the inverter is short-circuited. 2. If the error message persists, contact installation partner.
Load short circuit	Output short circuit.	<ol style="list-style-type: none"> 1. Remove load. 2. Restart system.

8.2 Maintenance

	Danger!
	<p>Please pay attention to the following matters</p> <ul style="list-style-type: none"> • Do not place RX-5000AC near the fire, there may be explosion risk. • Do not open RX-5000AC without permission.
	Danger!
	<p>Please read the following items carefully before installation:</p> <ol style="list-style-type: none"> (A) Remove watches, rings or other metallic objects. (B) Use tools with insulated handles (C) Wear rubber gloves and insulated shoes



The repair of the battery should be carried out or supervised by personnel with battery knowledge and necessary precautions. Do not mix batteries of different types and capacities, please use all batteries of the same model. If the inverter is not used for more than 7 days, turn off the AC input and battery input switches.

If it has not been used for more than 3 months, turn on the AC input switch and battery switch, and start the system to replenish the battery once.

Maintenance of batteries should be carried out or supervised by authorized personnel and necessary protection measures should be taken. Do not mix batteries of different types and capacities. All the battery should be the same model.

If the inverter is not in use for more than seven days, turn off the AC input and battery input switches.

If it has not been used for more than 3 months, turn on the AC input switch and the battery switch to start the system to recharge the battery once.

8.3 Routine Maintenance

Item	Method	Period
System Clean	Check the temperature and dust of the Storage Unit. Clean the unit enclosure if necessary.	Six Months to a year
Cable Entry	Check whether the cable entry is insufficiently sealed or the gap is excessively large; and reseal the entry when necessary.	Once a year
Electrical Connection	Check whether all cables are firmly in place. Check whether a cable is damaged (rodents. Physical damage, weather etc).	Once a year

9 Redx Power App

The Redx Power APP can establish communication connection to the energy storage unit via Bluetooth / WIFI and or 4G (optional) network. Users can use the APP to view basic information, alarms, and events, set parameters, or download logs etc.

Note: Install the APP or open web page according to the attached instructions, and then configure the WIFI connection. The last page of the manual has a QR code to install the App.

10 Quality Assurance

When a product faults during the warranty period. REDX will provide a new product.

Evidence

During the warranty period, the customer shall provide the product purchase invoice and date.

Since the date of purchase by the user from Redx (hereinafter referred to as the manufacturer), the user will enjoy the following after-sales warranty service

- 1.A 10-year warranty commences from the date of shipment from, during the warranty period the company provides free repair or replacement of new products.
- 2.Any paid service (extended warranty) is available from the date of shipment from manufacturer.
- 3.Disclaimer: Product faults caused by the following reasons are not within the scope of the manufacturer's 10 years warranty commitment:
 - (a) The user does not perform the correct operation according to the procedures listed in the product specification.
 - (b) Repairing the product without communicating with the manufacturer or changes the product without permission, resulting in product failure.
 - (c) Users not following the standards.
 - (d) The fault of the module caused by unsuitable environment.
 - (e) Due to earthquake, fire, natural disasters, lightning strike, abnormal voltage raise, ionizing radiation or other natural disasters caused by external factors.

4. Under the following circumstances, the manufacturer has the right not to provide warranty service.

- (a) Brand, trademark, serial number, nameplate and other marks marked by the manufacturer in the product are damaged or cannot be identified.
- (b) The customer fails to pay off the products according to the Purchase and Sales Contract signed by both parties.
- (c) The user intentionally conceals the improper use of the product during installation, wiring, operation, maintenance or other processes to the after-sales service provider of the manufacturer.

*Redx reserve the right to change the contents of this specification and product performance without informing users.

11 Appendix

11.1 Optional Accessories

The following table lists the optional accessories of the system, contact the manufacturer or distributor for further information

Name	Notes / Purpose
Data Collector	Data Collector (Wi-Fi)
Data Collector	Data Collector (4G)
CT	Current Transformer
Smart Meter	Single phase smart meter

Note: The anti-backflow function requires a smartmeter and CT.

12 Contact

If you have any questions about our products, please contact our service hotline or dealers. please provide the following information when inquiring:

- 1.System serial number
- 2.System model
- 3.Fault code/Name
- 4.Briefly describe the fault symptom

13 Backup Declaration

Declaration for Backup Function — Redx Technologies

The following outlines Redx Technologies' general policies regarding the hybrid inverters described in this document:

1. For Redx hybrid inverters, the electrical installation typically includes connections to both modules and battery systems. In backup mode, if no power is available from either the batteries or the PV modules, the backup power supply will automatically shut down. Redx Technologies accepts no liability for any consequences resulting from failure to follow this instruction.
2. Under normal conditions, the backup switching time is less than 10 milliseconds. However external factors may cause the system to fail to operate in backup mode. Users must be aware of the following guidelines:
 - Do not connect loads that require a continuously stable energy supply for safe operation (e.g., critical medical equipment).
 - Do not connect loads exceeding the inverter's maximum backup capacity.
 - Do not connect loads with high start-up surge currents, such as air conditioners, high-power pumps, vacuum cleaners, or hair dryers.
 - Battery performance, including output current, may be affected by factors such as temperature, weather conditions, and the battery's own characteristics.

Declaration for Backup Overload Protection — Redx Technologies

In the event of overload protection activation, the inverter will automatically restart. If overload conditions repeat, the system's restart time may sometimes extend up to 10 minutes. Users are advised to:

- Reduce the total backup load to within the recommended limits.
- Disconnect or avoid using appliances that create high start-up current surges.

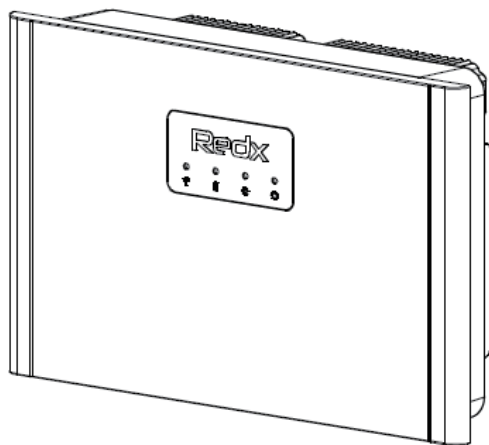



For more information, please scan QR code or visit
www.redx.com.au



Download the Redx App with the above QR Code



Redx



Address: Unit 2/21 Millennium Circuit, Helensvale, QLD Australia 4212

Website: www.redx.com.au

Email: info@redx.com.au

Phone: 61 7 5672 9983

Specifications are subject to change without advance notice.